



# Instruction Manual

## MB120 Moisture Analyzer





## Table of Contents





1.	GETTING TO KNOW YOUR MOISTURE ANALYZER .....	1
1.1	Introduction.....	1
1.2	Overview of the Moisture Analyzer .....	1
1.3	What is a Moisture Analyzer? .....	1
2.	SAFETY INFORMATION.....	2
2.1	Definition of Signal Warnings and Symbols .....	2
2.2	Product Specific Safety Notes .....	3
3.	INSTALLATION .....	5
3.1	Unpacking and checking the standard equipment.....	5
3.2	Selecting the Location.....	5
3.3	Installing the Tray Pan, Draft Shield and Pan Support .....	6
3.4	Leveling the Moisture Analyzer.....	6
3.5	Connecting to a Power Supply.....	7
3.6	Switching the Moisture Analyzer on and off.....	7
4.	MAKING A SIMPLE MEASUREMENT.....	10
5.	MENU.....	10
6.	SETUP .....	11
6.1	Weight and temperature adjustment.....	11
6.1.1	Weight adjustment.....	11
6.1.2	Temperature adjustment .....	12
6.1.3	Weight adjustment record .....	12
6.1.4	Temperature adjustment record .....	15
6.2	User settings .....	15
6.2.1	Language .....	15
6.2.2	Brightness .....	16
6.2.3	Sound.....	17
6.3	Device settings.....	18
6.3.1	Date and Time.....	18
6.3.2	Peripherals .....	19
6.3.3	Print.....	21
6.3.4	GLP and GMP Data .....	22
6.4	User management.....	23
6.5	System and data management .....	26
7.	METHOD LIBRARY.....	31
7.1	Method load, edit and delete.....	31
7.2	Entering Method Name .....	31
7.3	Setting the Drying Profile .....	32

7.4	<i>Setting the Drying Temperature</i> .....	33
7.5	<i>Selecting the switch-off criterion</i> .....	33
7.6	<i>Displayed result</i> .....	35
7.7	<i>Target Weight</i> .....	36
7.8	<i>Starting Mode</i> .....	37
7.9	<i>Default method</i> .....	37
7.10	<i>Method export and import</i> .....	37
8.	<b>RESULTS</b> .....	39
8.1	<i>Test Results</i> .....	42
8.1.1	<i>Result data and curve</i> .....	43
8.1.2	<i>Statistics</i> .....	43
8.1.3	<i>Result export</i> .....	44
9.	<b>HOW TO OBTAIN THE BEST RESULTS</b> .....	42
9.1	<i>Measurement principle of the Halogen Moisture Analyzer</i> .....	42
9.2	<i>Sampling and sample preparation</i> .....	43
9.3	<i>Selection of the drying temperature</i> .....	46
9.4	<i>Selection of the drying program</i> .....	47
9.5	<i>Selection of the drying time</i> .....	48
9.6	<i>Analysis of the drying profile</i> .....	48
10.	<b>HELP INFORMATION</b> .....	52
10.1	<i>Level Assist</i> .....	50
10.2	<i>Temperature Guide</i> .....	51
11.	<b>PRINTING TEST DATA</b> .....	52
11.1	<i>RS232 Command Table</i> .....	54
11.2	<i>RS232 Pin out</i> .....	54
12.	<b>CARE AND MAINTENANCE</b> .....	55
12.1	<i>Cleaning Interior/Exterior Components</i> .....	55
12.2	<i>Replacing Power Line Fuse</i> .....	57
12.3	<i>Troubleshooting</i> .....	57
12.4	<i>Error detection</i> .....	58
12.5	<i>Service information</i> .....	59
12.6	<i>Accessories</i> .....	59
13.	<b>TECHNICAL DATA</b> .....	59
13.1	<i>Admissible ambient conditions</i> .....	59
13.2	<i>Specifications</i> .....	60
14.	<b>COMPLIANCE</b> .....	60
A.1	<b>APPLICATION EXAMPLES</b> .....	62

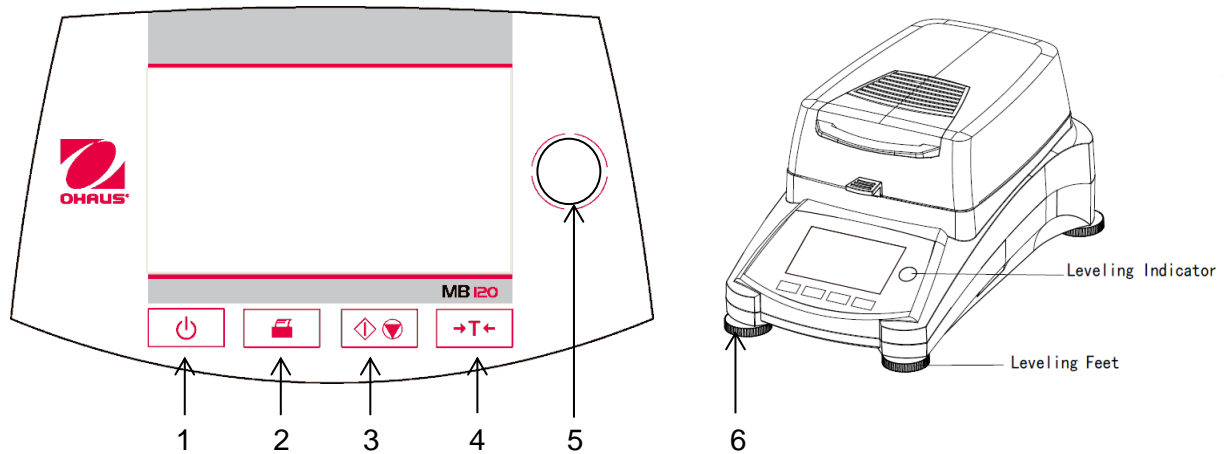

## Overview of Controls



1		Turns On or Off display.
2		When pressed, sends Print command.
3		When pressed, either starts or stops the drying process.
4		When pressed, performs Tare function.
5		Leveling indicator
6	Leveling Feet	Used to level the Moisture Analyzer.

# 1. GETTING TO KNOW YOUR MOISTURE ANALYZER

This section provides you with essential information on your MB120 Moisture Analyzer. Please read through the section carefully even if you have previous experience with OHAUS Moisture Analyzers and be sure to familiarize yourself with the safety notes.

## 1.1 Introduction

Thank you for deciding to purchase an MB120 Halogen Moisture Analyzer from Ohaus. Behind your instrument stands OHAUS, a leading manufacturer of precision Moisture Analyzers, Balances, Scales and Indicators. An Aftermarket Department with trained instrument technicians is dedicated to provide you with the fastest service possible in the event your instrument requires servicing. OHAUS also has a Customer Service Department to answer any inquiries regarding applications and accessories.

To ensure you make full use of the possibilities offered by your Moisture Analyzer, please read the manual completely before installation and operation.

You can also find and download the instruction manual at <http://dmx.ohaus.com/WorkArea/showcontent.aspx?id=4294974363>

## 1.2 Overview of the Moisture Analyzer

The Moisture Analyzer offers a high level of operating convenience and useful functions to make accurate measurements.

The Moisture Analyzer has the following features:

- Fully programmable with colorful touch screen
- Extremely rugged and chemically resistant construction.
- Ergonomic operating controls and a large, easily readable display.
- Easy to follow menus for simplified operation.
- Built-in functions for manual, automatic timing, printing intervals.
- Built-in selectable drying profiles.
- Able to set step heating levels to accommodate a variety of sample types.
- Built-in library stores up to 100 samples complete with setup parameters and statistics.
- Built-in RS232 and USB interface.
- Any of thirteen languages (English, Spanish, French, German, Italian, Russian, Polish, Czech, Hungarian, Portuguese, Chinese, Japanese, Korean)
- Display contains all test data during drying process.
- A variety of optional accessories includes disposable pan liners, temperature calibration kit, interface communication cables, printer, and a security device.

## 1.3 What is a Moisture Analyzer?

The Ohaus Halogen Moisture Analyzer can be used to determine the moisture content of practically any substance. The instrument operates on the thermogravimetric principle: At the start of the measurement, the Moisture Analyzer determines the weight of the sample; the sample is then quickly heated by the integral halogen dryer unit and moisture vaporizes. During the drying operation, the instrument continuously determines the weight of the sample and displays the result. On completion of drying, result is displayed as % moisture content, % solids, weight or % regain.

Of particular importance in practice is the rate of heating. In comparison with conventional infrared heating or the drying oven method, for example, the halogen dryer of your

instrument needs a shorter time to reach its maximum heating power. It also allows the use of high temperatures; an additional factor in shortening the drying time. Response times for the control of production are shorter resulting in increased productivity.

All parameters of a measurement (drying temperature, drying time, etc.) can be pre-selected. The Moisture Analyzer offers many other possibilities. A few of these are listed here:

- The integrated database for drying procedures stores the settings for your samples.
- The drying characteristics can be matched to the type of sample.
- Your settings and measurement results can be recorded and stored.
- Built-in battery backup stores valuable data during a power failure.

Even though the Moisture Analyzer contains many functions, operation remains simple. The four button controls on the front panel for the frequently usage: Power on/off, Print, Start/Stop and Tare. The 4.3" color touch screen allows entry into a variety of displays which includes a test library where previous samples are recorded along with the test parameters so that a similar sample can be run without the need to enter all new data. The color touch screen also indicates the method name, selected temperature, actual temperature, time and moisture content in percent, solids in percent, grams, % regain and a graphical display which illustrates the time and percentage.

Your Moisture Analyzer conforms with all common standards and directives. It supports standard procedures, work techniques and records as required by **GLP (Good Laboratory Practices)** and **SOP (Standard Operating Procedure)**. We recommend the use of the OHAUS SF40A Printer.

## 2. SAFETY INFORMATION

### 2.1 Definition of Signal Warnings and Symbols







Safety notes are marked with signal words and warning symbols. These show safety issues and warnings. Ignoring the safety notes may lead to personal injury, damage to the instrument, malfunctions and false results.

#### Signal Words

<b>WARNING</b>	for a hazardous situation with medium risk, possibly resulting in severe injuries or death if not avoided.
<b>CAUTION</b>	for a hazardous situation with low risk, resulting in damage to the device or the property or in loss of data, or minor or medium injuries if not avoided.
<b>Attention</b>	(no symbol) for important information about the product.
<b>Note</b>	(no symbol) for useful information about the product.



### Warning Symbols

	General hazard		Electrical shock
	Hot surface		Inflammable or explosive substance
	Toxic substance		Acid / Corrosion

## 2.2 Product Specific Safety Notes

### General Safety Information

Your instrument meets the state of the art technology and complies with all recognized safety rules, however, certain hazards may arise in extraneous circumstances. Do not open the housing of the instrument: It does not contain any parts which can be maintained, repaired or replaced by the user. If you ever have problems with your instrument, contact your authorized OHAUS dealer or service representative.

Always operate and use your instrument only in accordance with the instructions contained in this manual. The instructions for setting up your new instrument must be strictly observed.

**If the instrument is not used according to these Operating Instructions, protection of the instrument may be impaired and OHAUS assumes no liability.**

### Intended Use

Your Moisture Analyzer is used for determining the moisture in samples. Use the instrument exclusively for this purposes. Any other type of use and operation beyond the limits of technical specifications without written consent from OHAUS, is considered as not intended. Moisture determination applications must be optimized and validated by the user according to local regulations. Application-specific data provided by OHAUS is intended for guidance only.



It is not permitted to use the instrument in explosive atmosphere of gases, steam, fog, dust and flammable dust (hazardous environments).

### Staff Safety

The Moisture Analyzer may be operated only by trained personnel who are familiar with the properties of the samples used and with the handling of the instrument.

In order to use the instrument, you must have read and understood the operating instructions. Keep the operating instructions for further reference.

Never make any modifications to the instrument and use only original spare parts and optional equipment from OHAUS.

### Protective Clothing

It is advisable to wear protective clothing in the laboratory when working with the instrument.



A lab coat should be worn.



A suitable eye protection such as goggles should be worn.



Use appropriate gloves when handling chemicals or hazardous substances, checking their integrity before use.

### Safety Notes



#### **WARNING**

##### **Risk of electric shock**

Your instrument is supplied with a 3-pin power cable with an equipment grounding conductor. Only extension cables which meet this relevant standards and also have an equipment grounding conductor may be used. Intentional disconnection of the equipment grounding conductor is prohibited.



#### **CAUTION**

##### **The Halogen Moisture Analyzer works with heat!**

- a) Ensure sufficient free space around the instrument to avoid heat accumulation and overheating (approx. 1 m free space above the heating module).
- b) The vent over the sample must never be covered, plugged, taped over or tampered with in any other way.
- c) Do not place any combustible materials on, under or next to the instrument since the area around the heating module may be hot.
- d) Exercise caution when removing the sample. The sample itself, the sample chamber, the draft shield and any sample vessels used may still be very hot.
- e) During operation, you should never open the heating module itself as the ring-shaped heating reflector or its protective glass can reach 400 °C! If you have to open the heating module e.g. for maintenance, disconnect the instrument from the power supply and wait until the heating module has cooled down completely.
- f) No modifications must be made within the heating module. It is particularly dangerous to bend any components or remove them or to make any other changes.

### **Certain samples require special care!**

With certain types of samples, there is a possibility of danger to personnel or damage of property.

Please note that the user always has the responsibility and liability for damage caused by use of any types of samples!



#### **CAUTION**

##### **Fire or Explosion**

- Flammable or explosive substances.
  - Substances containing solvents.
  - Substances which evolve flammable or explosive gases or vapors when heated.
- a) In cases of doubt, perform a careful risk analysis.
  - b) Work at a drying temperature that is low enough to prevent the formation of flames or an explosion.
  - c) Wear protective goggles.
  - d) Work with small amounts of sample.
  - e) **Never leave the instrument unattended!**

**WARNING****Substances which contain toxic or caustic components**

Toxic gases produced during drying could cause irritations (eyes, Skin, breathing), illness or death.

- Such substances may be dried only in a fume cupboard.

**CAUTION****Corrosion**

Substances which evolve corrosive vapors when heated (e.g. acids).

- Work with small amounts of samples as the vapor can condense on cooler housing parts and cause corrosion.

### 3. INSTALLATION

In this section, you will learn how you unpack and install your new Moisture Analyzer and prepare it for operation. On completion of the steps described in this section, your Moisture Analyzer is ready for operation.

#### 3.1 Unpacking and checking the standard equipment

Open the package and remove the instrument and the accessories. Check the completeness of the delivery.

The following accessories are part of the standard equipment of your new Moisture Analyzer.

- 1 Box, Aluminum sample pans
- 1 Pan support
- 1 Glass fiber Pad
- 1 Draft shield
- 1 Tray Pan
- 1 Power cable
- 1 Pan Handle
- 1 Spoon
- 1 Quick Guide

Remove packing material from the instrument.

Check the instrument for transport damage. Immediately inform your Ohaus dealer if you have complaints or parts are missing.

Store all parts of the packaging. This packaging guarantees the best possible protection for the transport of your instrument.

#### 3.2 Selecting the Location

The Moisture Analyzer should always be used in an environment which is free from excessive air currents, corrosives, vibration, and temperature or humidity extremes. These factors will affect displayed weight readings.

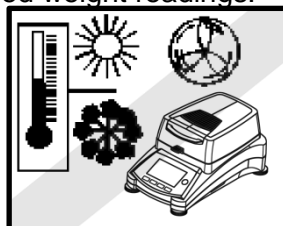
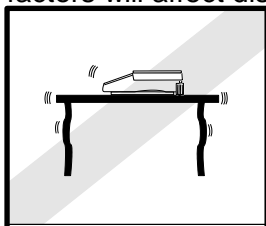

**DO NOT** install the Moisture Analyzer:

- Next to open windows or doors causing drafts or rapid temperature changes.
- Near air conditioning or heat vents.
- Near vibrating, rotating or reciprocating equipment.

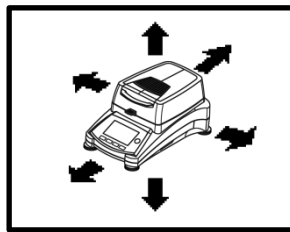
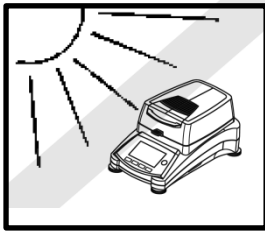

- Near magnetic fields or equipment that generate magnetic fields.
- On an unlevel work surface.
- In confined areas, allow sufficient space around the instrument for ease of operation and keep away from radiating heat sources.

### 3.3 Installing the Tray Pan, Draft Shield and Pan Support

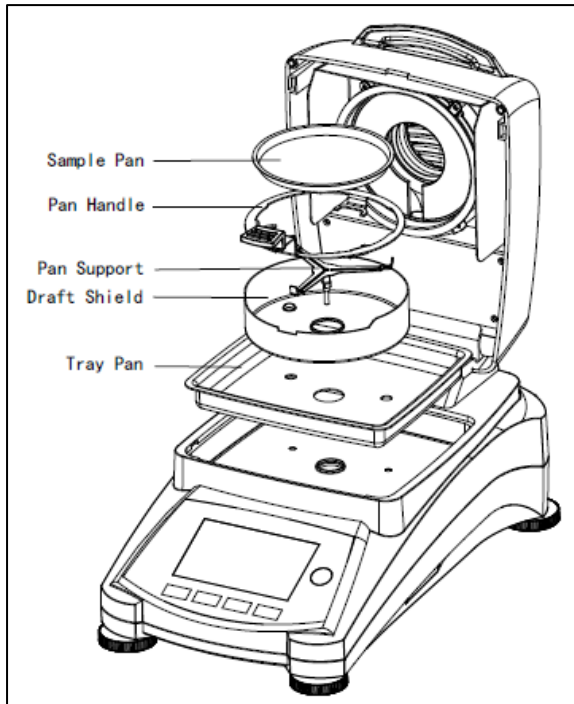

Lift the cover straight up and install the tray pan in the base of the heating chamber.

Install the draft shield (only one position possible) on top of the tray pan.

Install the pan support into position. Turn the pan support until it engages. In the locked position, the arm of the pan support points directly towards the front of the analyzer.

### 3.4 Leveling the Moisture Analyzer

Exact horizontal positioning and stable installation are prerequisites for repeatable results. To compensate for small irregularities or inclinations at the location, the instrument can be leveled.

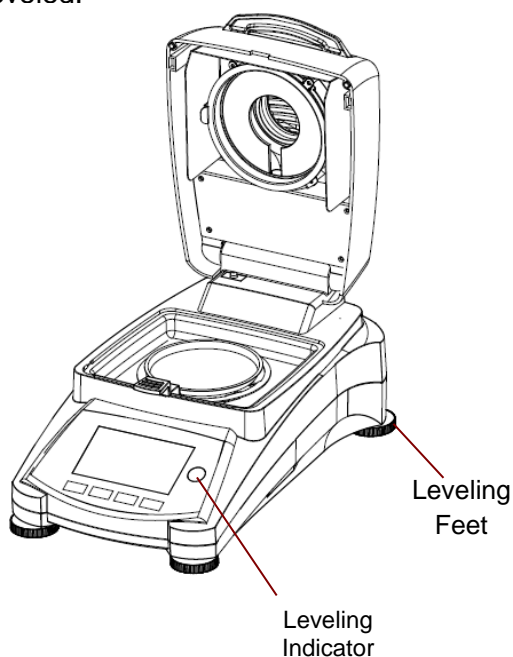

Adjust the leveling feet of the Moisture Analyzer until the air bubble in the indicator is centered. The level indicator is located under the cover towards the rear of the Moisture Analyzer.

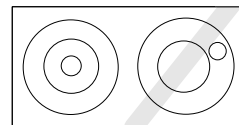

Attention: The instrument should be leveled each time its location is changed.

### 3.5 Connecting to a Power Supply



**WARNING:** Risk of electric shock.

- Use only the 3-pin power cord with equipment grounding connector which was supplied with your instrument. Only connect the power cord to a 3-pin ground outlet.
- Only extension cords which meet the relevant standards and also have an equipment grounding conductor may be used.

**Attention:**

Check to ensure the voltage stated on the Moisture Analyzer’s data label matches your local line voltage. If this is not the case, do not connect the Moisture Analyzer to the power supply, contact your responsible OHAUS dealer.

The halogen dryer unit is designed to operate at a specific line voltage (120V AC or 240V AC). The dryer unit is installed at the factory and is matched to the particular line voltage of the country of destination.

Connection to a line voltage that is too high can lead to burning out the halogen heater, whereas, a supply voltage that is too low will prolong the drying process and the instrument may not operate properly.

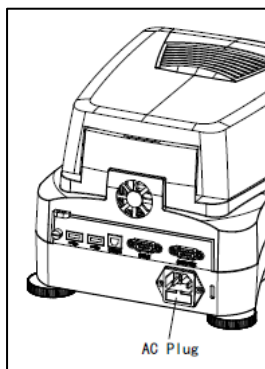

Connect the power cord to the power supply socket located at the rear of the Moisture Analyzer and to the power supply outlet. The Moisture Analyzer becomes operational as soon as power is applied. The display will remain off until the **On/Off** button is pressed.

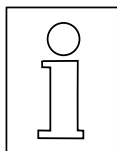

**Allow the Moisture Analyzer to warm up for at least 30 minutes** to enable it to adapt itself to the ambient conditions. If the Moisture Analyzer has been stored in a very cold environment before installation, it may require several hours for it to stabilize.



**WARNING:**

If the power cable supplied is not long enough, use only a **proper 3-pin extension cable with an equipment grounding connector**.

### 3.6 Switching the Moisture Analyzer on and off

Your Moisture Analyzer is on at all times when connected to a power source. The display can be turned on or off.



To **switch the Moisture Analyzer on**, press the **On/Off** button. An internal diagnostic test is performed; the display lights and the Home screen appears followed by the initial display.

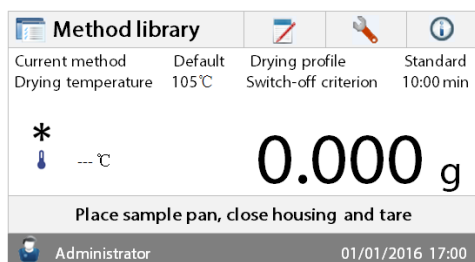

To **switch the Moisture Analyzer off**, press the **On/Off** button. After the analyzer has been switched off, it is in the standby mode. If you wish to perform a test, press the **On/Off** button again.

**Note:**

As your Moisture Analyzer needs no warm-up time when in the standby mode and is immediately ready for testing samples, we advise you to switch the display off by use of the On/Off button and not to disconnect it from the power supply. This also ensures that the Moisture Analyzer is always in thermal equilibrium.

## 4. MAKING A SIMPLE MEASUREMENT

With your Moisture Analyzer powered on, you are ready to operate for the first time and perform a simple measurement. For this simple test, you will enter the Default method and enable the test. By doing this test, you will become familiar with the instrument. Included with your Moisture Analyzer is a specimen sample for your first measurement. This sample is an absorbent glass fiber pad. During your first measurement, the instrument operates with the factory settings.

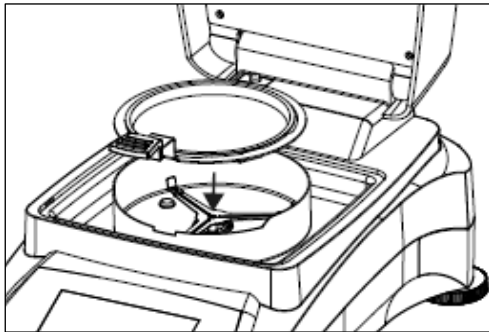

If the display is not visible and the unit is plugged into a power source, press the On/Off button.

**Directly start a measurement.**

Open the cover on the Moisture Analyzer.

Clean the pan.

Place the pan handle in the sample chamber. Ensure that the tongue of the pan handle fits exactly in the slot of the draft shield element.

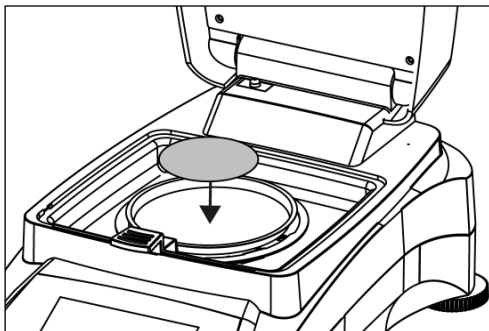

Place the empty sample pan and glass fiber pan in the pan handle. The sample pan must lie flat in the pan handle.

**Attention:** It is advisable for you to work with the pan handle at all times. The pan handle is ergonomic, safe and provides protection against possible burns due to a hot sample pan.

Close the cover. This sets the Moisture Analyzer to zero automatically.

Open the cover on the Moisture Analyzer.

Wet the glass fiber pan with a 0.5 to 1 gram of water.

**Attention: Minimum sample size must be greater than 0.5 gram.**

**Starting the test**

Close the cover, the Moisture Analyzer starts the drying and measurement process automatically.

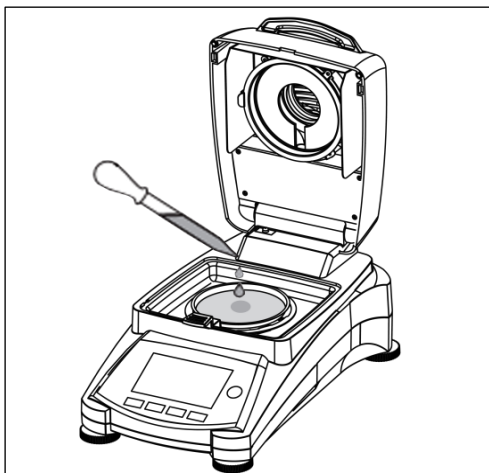



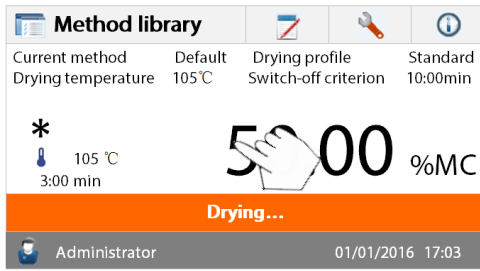

**Drying and measurement**

You are now able to follow the progress of the drying cycle on the display. This first display comes up automatically when the test was started.

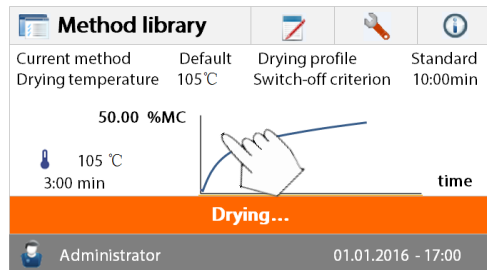

**Observing the test progress**

There are two displays available when the Moisture Analyzer is running a test. One showing the %MC value and another showing a curve.

When pressing the data area while %MC is shown, the display will switch to show the curve. Likewise, pressing the data area again will switch back to show the %MC value.

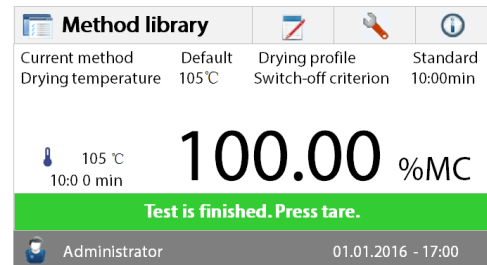

The display indicates the Method Name, Temperature/Time, actual temperature, elapsed time duration of the test, moisture and curve. The test automatically stops at the end of the measurement. If you want to end the test sooner, press the  button.

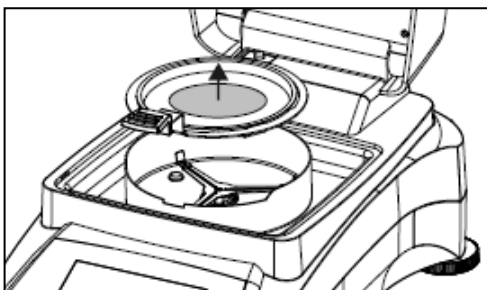

**Congratulations!** You have just performed your first measurement with your moisture analyzer.



**CAUTION:** Danger of burns. Sample, sample pan and sample pan holder may still be hot.

Open the cover and carefully remove the sample pan handle from the drying area.

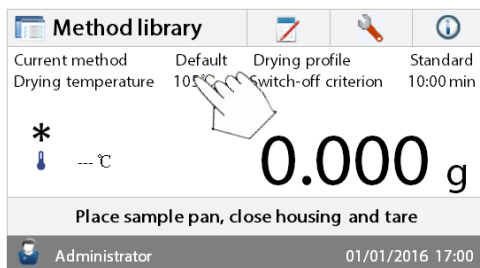

The analyzer comes with a default method preinstalled. The settings of the default method are shown on the display. To edit the settings, press on the area where the settings are displayed as shown to the left.

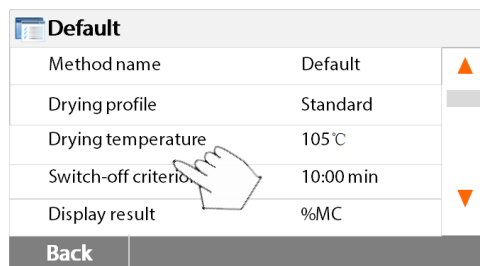

Press the setting items to edit them. Please see section 7 for more details.

## 5. MENU

The Home screen appears after the moisture analyzer has been switched on.

1	2	3	4	
				Button area
				Current Method
				Results area
				Instructions area
				User name, date and time area

- 1. Method library: Change parameters and create new method.
- 2. Test results: Manage test results.
- 3. Setup: Change system settings.
- 4. Help information: Temperature guide and help information.

### Method Library

Press the Method library button to access the Method library menu.

The Method library contains up to 100 methods. All methods which were previously entered can be recalled and the parameters for the recalled method when selected will be repeated.

Press the button to sort the method name by ascending or descending alphabetical order.

### Test Results

  

Press the Test results button to access the test results menu.

The Test results contains up to 1000 test results. All results can be recalled, sorted and displayed statistically.



## Setup

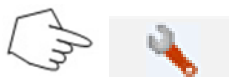

Press the Setup button to access the Setup menu.



## Help Information



Press the Help button to access the Help menu.

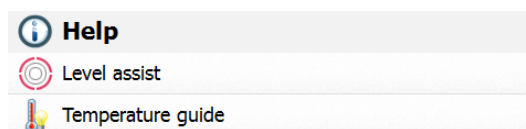

## 6. SETUP

The setup menu is activated by pressing the Setup button. The menu contains: weight and temperature adjustment, user settings, device settings, user management and system and data management.

### 6.1 Weight and temperature adjustment

#### 6.1.1 Weight adjustment

The Moisture Analyzer can be adjusted with an external mass of 50 grams. Adjustment of the Moisture Analyzer is not absolutely necessary for a correct moisture determination as the measurement is relative. The balance determines the weight of the sample before and after drying and the moisture is calculated on the basis of the ratio between wet and dry weights. Nevertheless, you should adjust the built-in balance under the following conditions:

- If this is stipulated by your quality assurance system (GLP, GMP, ISO 9001).
- If you suspect the analyzer has been abused.

To adjust the analyzer, proceed as follows:

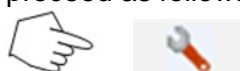

Press the Setup button to access the Setup menu.

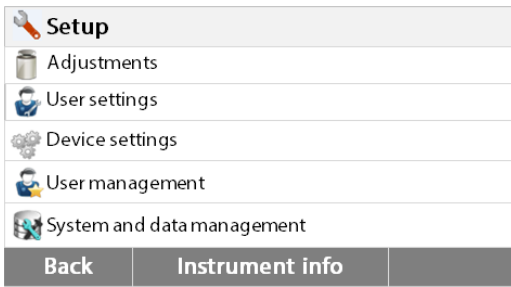

Press **Back** to return to Home screen.

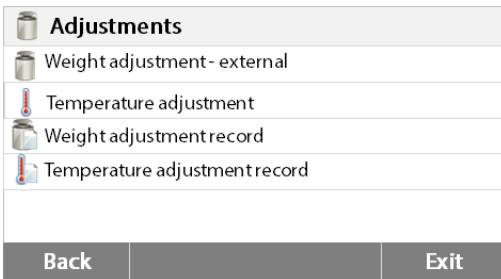

Press the Weight and temperature adjustment button to access adjustment menu.

Press **Back** to return to previous step.

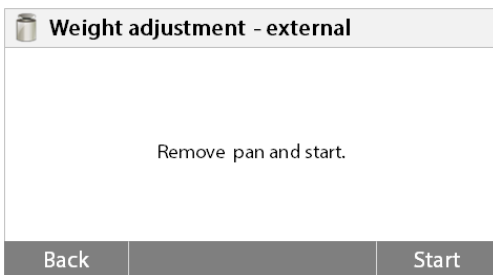

Press the Weight adjustment-external button

The display highlights the action you should take.

Follow the instructions on the display. Remove the sample pan. Place the required weight on the sample pan, close the cover. The display indicates if the adjustment was successful.

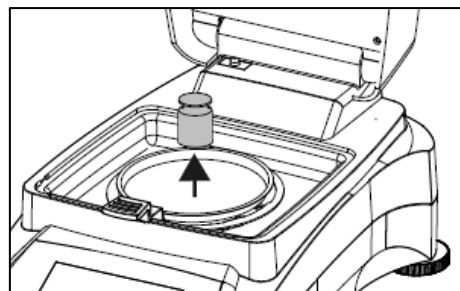
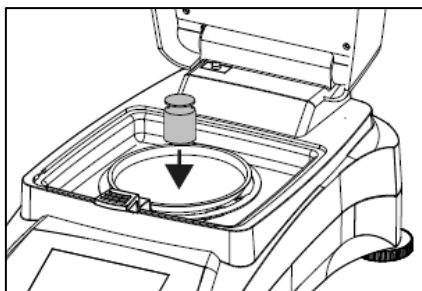

### 6.1.2 Temperature adjustment

You must have a temperature calibration kit to perform this procedure. If the Moisture Analyzer has been recently used, allow at least 30 minutes before performing adjustment.

**Note:** The temperature calibration kit is available as optional equipment.



Press Setup button to access the adjustment menu.

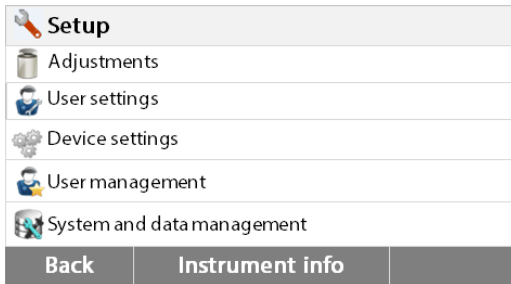

Press **Back** to return to Home screen.

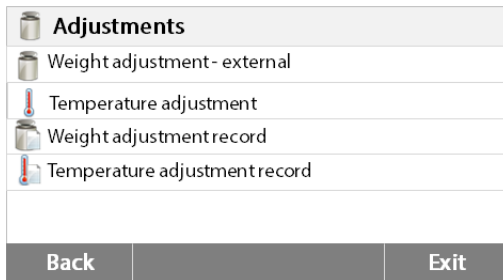

Press Weight and temperature adjustment button.

Press **Back** to return to previous screen.  
Press **Exit** to return to Home screen.

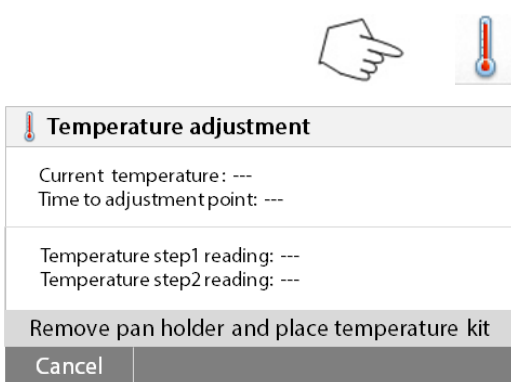

Press Temperature adjustment button.

You are now prompted to remove the pan support. Place a temperature calibration kit and close the upper housing.

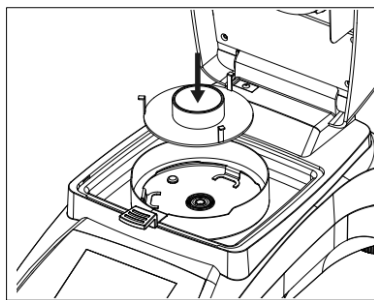

Press the **Start** to initiate the temperature adjustment process. Follow the screen prompts throughout the process.

The dryer unit is heated to a temperature of 100°C. You can observe the progress on the display as the dryer temperature and count down period are displayed. After 15 minutes, read the thermometer through the inspection window on the cover and enter this temperature. Adjust the display reading to agree with the thermometer, then press the **Enter** button. You have 15 minutes to make this adjustment, otherwise the adjustment is terminated.

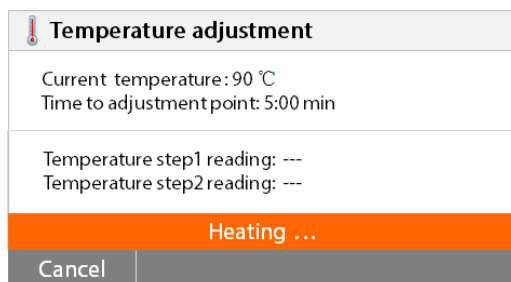

Cancel

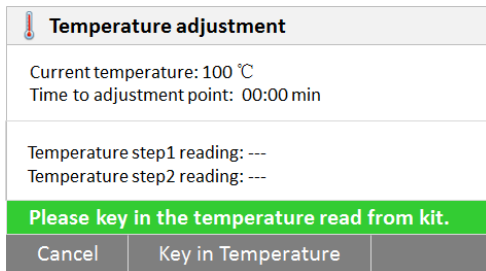

This is a two-point adjustment (100°C and 160°C). The dryer unit now heats to the second temperature (160°C). Adjustment of the temperature is defined by two points. Proceed exactly as you did for the first temperature. After you have set the display to agree with the thermometer, then press the **Enter** button.



**CAUTION: Danger of burns.**

Be careful when removing the temperature calibration kit from the dryer unit as it can be very hot. Allow it to cool down by opening the cover before removing. Remove the calibration kit. Replace the pan support in its proper positions.

**6.1.3 Weight adjustment record**

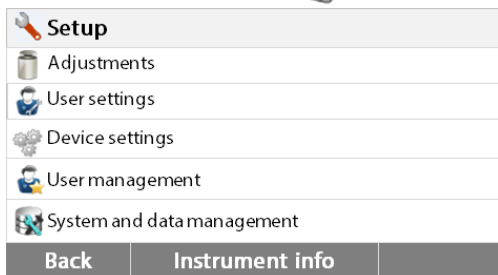

Press Setup button to access the Setup menu.  
Press **Adjustment** to access the adjustment menu.  
Press **Back** to return to **Home** screen.

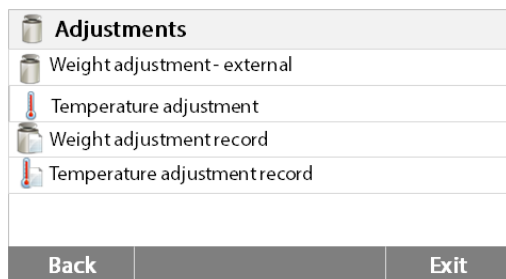

Press **Weight adjustment record** to list the weight adjustment record data.  
Press **Back** to previous step.  
Press **Exit** return to **Home** screen.

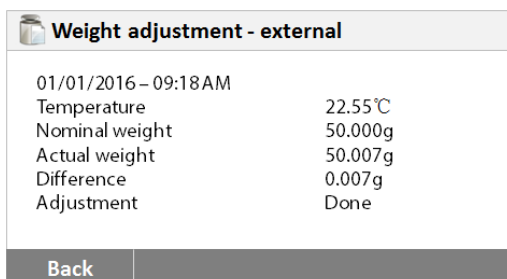

## 6.1.4 Temperature adjustment record

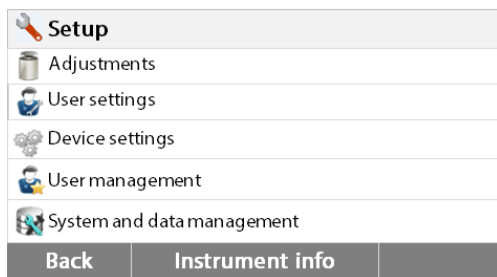

Press the Setup button to access the Setup menu.

Press **Back** to return to Home Screen.

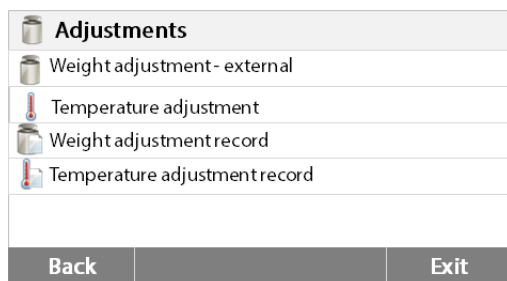

Press the Weight and temperature adjustment button to access the adjustment screen.

Press **Back** to return to previous screen.  
Press **Exit** to return to Home screen.

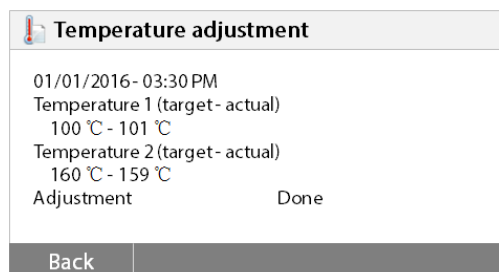

Press the Temperature adjustment history button.

Here you will find the last temperature adjustment result.  
Press **Back** to return to previous screen.

## 6.2 User settings

### 6.2.1 Language

For convenience, the Moisture Analyzer is equipped with thirteen languages available on all displays. The following steps show how to set a language.

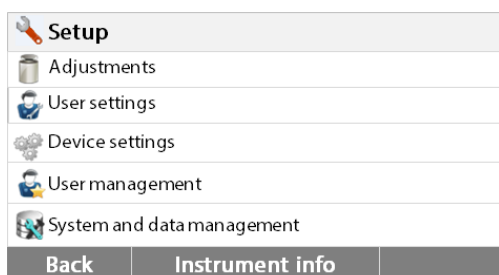

Press the Setup button to access the Setup screen.

Press **Back** to return to Home screen.

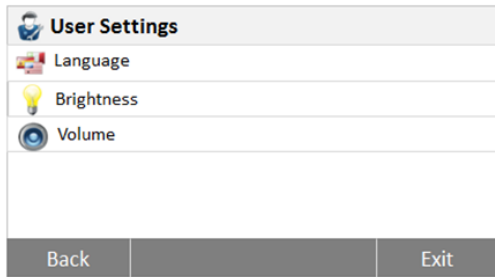

Press **User settings** to access the user settings menu.

Press the **Language** button.

Select LANGUAGE.

**Note:** If you select English as the dialog language, the date format is changed and appears on all records in the MM/DD/YYYY format.

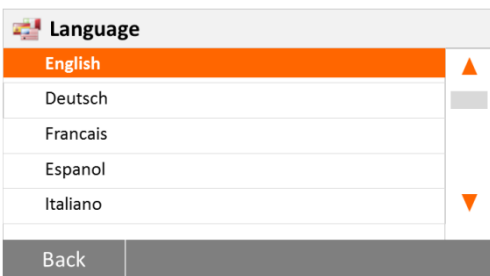

### 6.2.2 Brightness

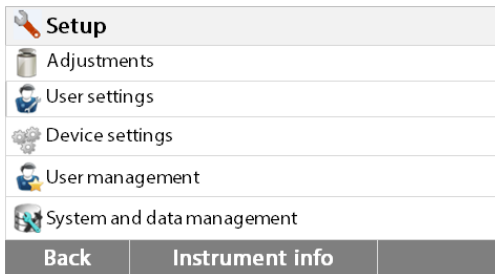

Press the **Setup** button to access the Setup menu.

Press **Back** to return to Home screen.

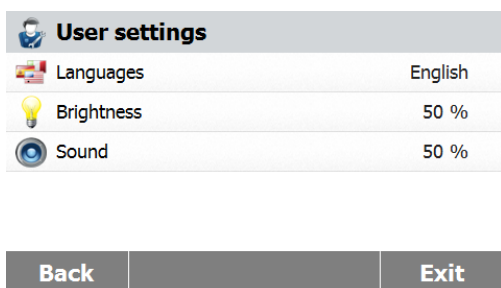

Press **User settings** button to access the User settings menu.

Press **Back** to return to previous screen.  
Press **Exit** to return to Home screen.



Press the **Brightness** button.

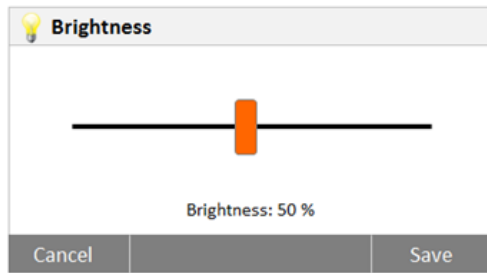

Adjust the brightness of the screen to desired level.

### 6.2.3 Sound

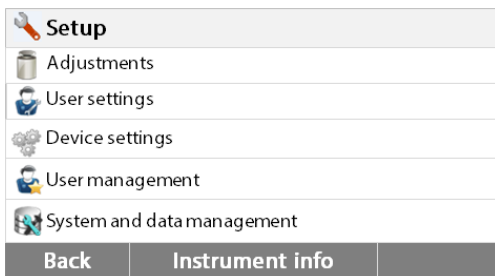

Press the **Setup** button to access the Setup menu.

Press **Back** to return to previous screen.

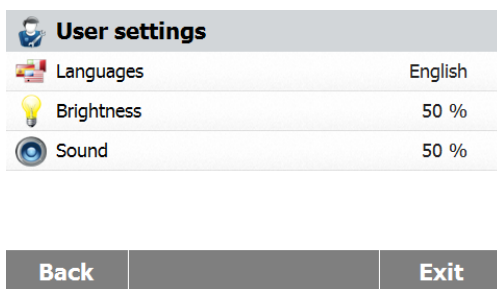

Press **User settings** button to access the User settings menu.

Press **Back** to return to previous screen.

Press **Exit** to return to Home screen.

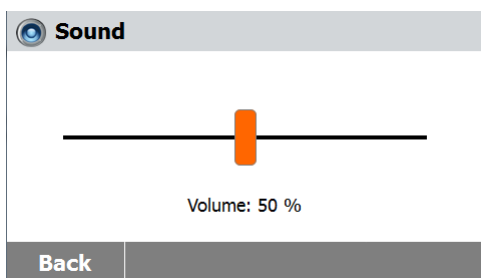

Press the **Volume** button.

Adjust the volume of the beep to desired level.

## 6.3 Device settings

### 6.3.1 Date and Time

This Moisture analyzer has a communication output which allows printing the date and time on every record. When this instrument is put into operation for the first time, you should enter the current date and time. These settings are retained even if you disconnect your instrument from the power supply. A built-in battery will maintain all data. To set the date and time, proceed as follows:



<b>Setup</b>		
	Adjustments	
	User settings	
	Device settings	
	User management	
	System and data management	
<b>Back</b>	<b>Instrument info</b>	

Press the **Setup** button to access the setup menu.

Press **Back** to return to previous screen.



<b>Device settings</b>		
	Date-Time settings	
	Peripheral settings	
	Print settings	
	GLP GMP data	
	Touch screen adjustment	
<b>Back</b>		<b>Exit</b>

Press **Device settings** to access the Device settings menu.

Press **Back** to return to previous screen.

Press **Exit** to return to Home screen.



<b>Date-Time</b>	
Date Format	DD.MM.YYYY
Date	08.04.2015
Time Format	24 Hour
Time	20:58
<b>Back</b>	<b>Exit</b>

Press the **Date-Time** button.

Press the following items to set the date and time.

Press **Back** to return to previous screen.

Press **Exit** to return to Home screen.

<b>Date Format</b>	
DD.MM.YYYY	
MM/DD/YYYY	
YYY/MM/DD	
<b>Back</b>	

Set the date format.

Press **Back** to return to previous screen.



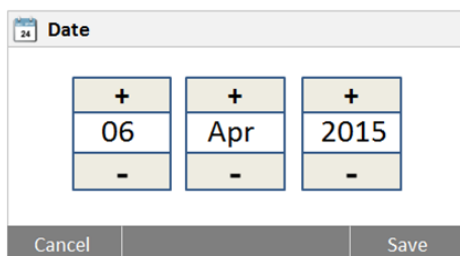

Set the date.  
Press + and – to set the correct date, month and year.

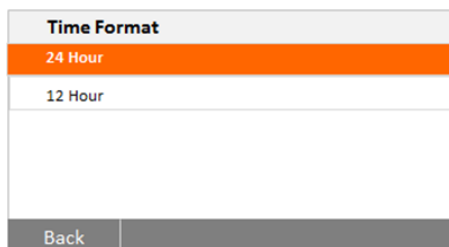

Set the time format.

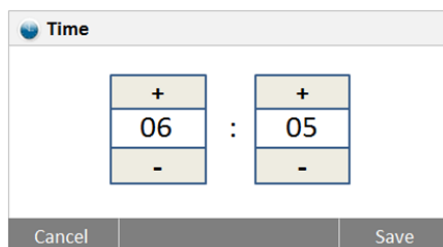

Set the time.  
Press + and – to set the correct time.

### 6.3.2 Peripherals

This Moisture Analyzer is equipped with USB and RS232 compatible interfaces for communication with USB storage devices, printers and computers. The following sections describe the hardware and software provided with the Moisture Analyzer.



Press the **Setup** button to access the Setup menu.  
Press **Back** to return to Home screen.

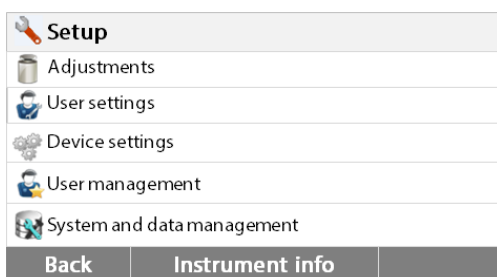

Press the **Device settings** button to access the Device settings menu.

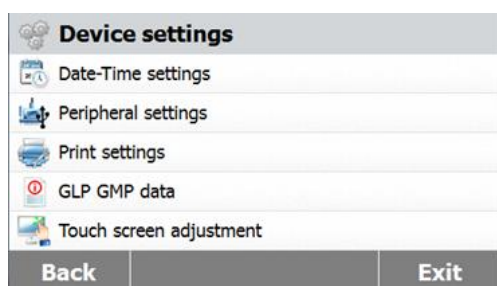

Press **Back** to return to previous screen.  
Press **Exit** to return to Home screen.



Press the **Peripheral settings** button.

RS-232	
Device Port	COM1
Baudrate	9600
Data Bits	8
Parity	None
Stop Bits	1 Stop Bit
<div style="display: flex; justify-content: space-between;"> <span>Back</span> <span>Exit</span> </div>	

Select the following items to set RS232 port when RS232 port link to printer or other RS232 compatible device.

Press **Back** to return to previous screen.

Press **Exit** to return to Home screen.

Device Port	
COM1	▲
COM4	■
▼	
<div style="display: flex; justify-content: space-between;"> <span>Back</span> </div>	

**Set the Device port**

Select the com1 for RS232, com4 for USB

Baudrate	
1200	▲
2400	■
4800	■
9600	■
19200	▼
<div style="display: flex; justify-content: space-between;"> <span>Back</span> </div>	

**Set the Baud rate**

Select the desired baud rates to 1200, 2400, 4800, 9600, 19200, 38400, 57600 or 115200. Default setting is 9600.

Date Bits	
7	■
8	■
<div style="display: flex; justify-content: space-between;"> <span>Back</span> </div>	

**Set the Data bits**

Select the desired data bits to 7 or 8. Default setting is 8.

Parity	
None	■
Odd	■
Even	■
<div style="display: flex; justify-content: space-between;"> <span>Back</span> </div>	

**Set the Parity**

Select the desired parity setting to either NONE,EVEN or ODD. Default setting is NONE.

Stop Bits	
1 Stop Bit	■
2 Stop Bits	■
<div style="display: flex; justify-content: space-between;"> <span>Back</span> </div>	

**Set the Stop bits**

Select the desired stop bits to 1 or 2. Default setting is 1.

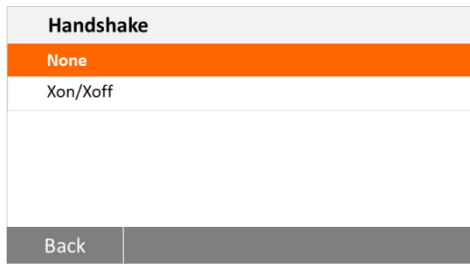

**Set the Handshake**

Select the desired handshake to NONE, Xon/Xoff. Default setting is NONE.

**6.3.3 Print**

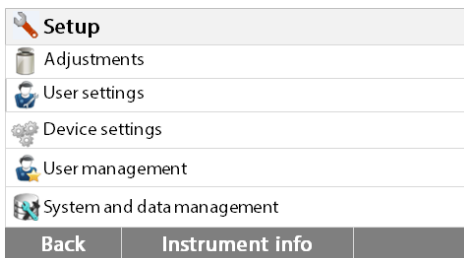

Press **Setup** button to access the Setup menu.

Press **Back** to return to Home screen.

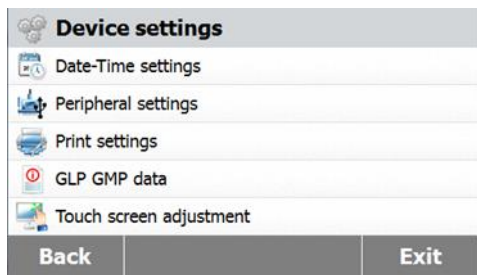

Press the Device settings button.

Press **Back** to return to previous screen.  
Press **Exit** to return to Home screen.

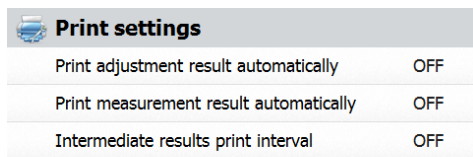

Press the **Print settings** button to access the Print settings menu.

Press **Print adjustment result automatically** to switch ON or OFF.

Press **Print measurement result automatically** to switch ON or OFF.

Press **Intermediate results print interval** to set the print interval.

Press **Back** to return to previous screen.

Press **Exit** to return to Home screen.

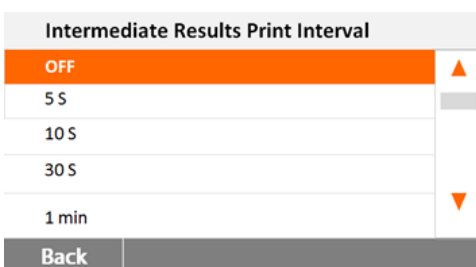

Press the **Intermediate results print interval** button.

Choose the interval seconds or minutes.

### 6.3.4 GLP and GMP Data

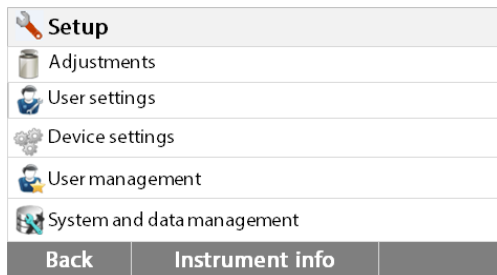

Press the **Setup** button to access the setup menu.

Press **Back** to return to Home screen.

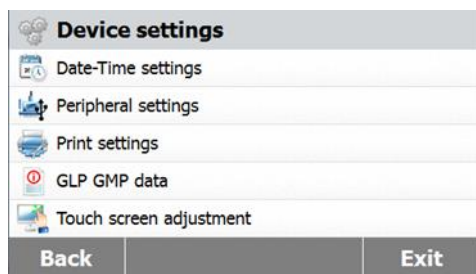

Press the **Device settings** button to access the Device menu settings.

Press **Back** to return to previous screen.  
Press **Exit** to return to Home screen.

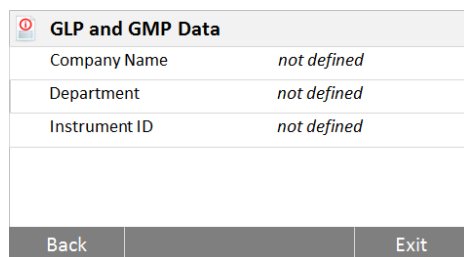

Press **GLP and GMP Data** to access the GLP and GMP Data menu.

Press **Company name, Department or Instrument ID** buttons to define related information.

Press **Back** to return to previous screen.  
Press **Exit** to return to Home screen.

### 6.3.5 Touch Screen Adjustment

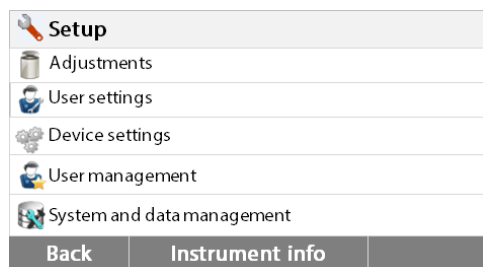

Press the **Setup** button to access Setup menu.

Press **Back** to return to Home screen.



Press **Device settings** to access the device settings.

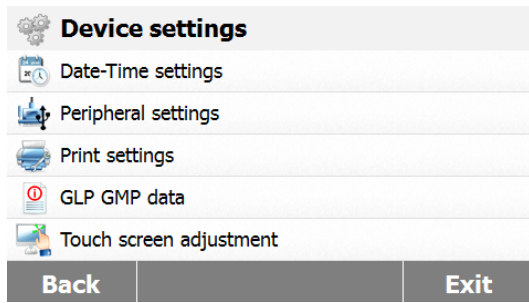

Press **Touch screen adjustment** to adjust the touch screen.

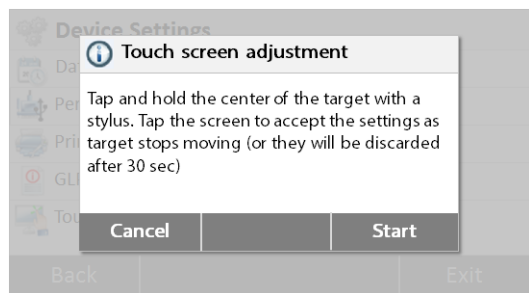

Press the **Start** button to start the adjustment.

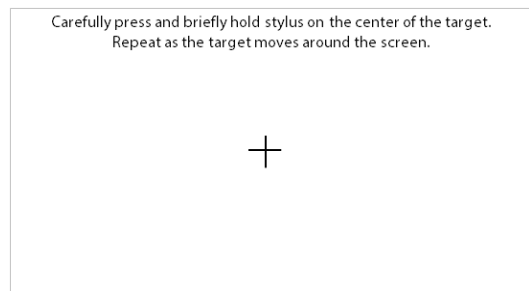

Please follow the displayed instructions to adjust the screen.

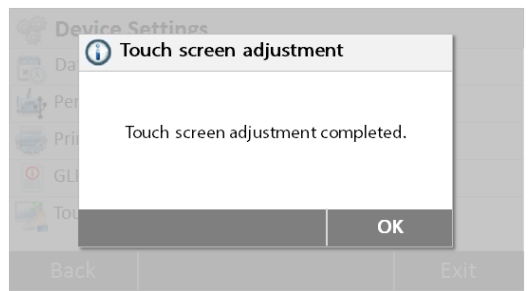

When the adjustment is completed, press **OK** to exit.

## 6.4 User management

### 6.4.1 Create new user account

There are three groups available and the default group with all access rights is administrator. The administrator group can not be deleted. 10 users can be created under the supervisor and operator group.

Group	Default access rights					
	Test execute	User settings	System settings	Method Edit	Adjustment	User and data management
Administrator	■	■	■	■	■	■
Supervisor	■	■	■	■	■	□
Operator	■	■	□	□	□	□

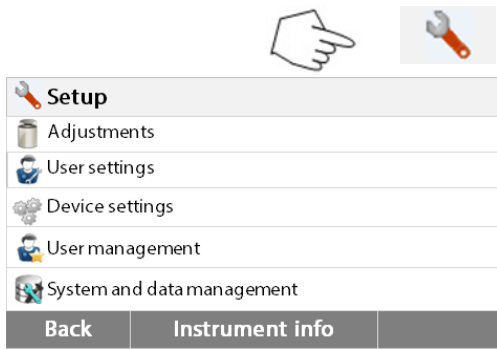

Press the **Setup** button to access Setup menu.

Press **Back** to return to Home screen.

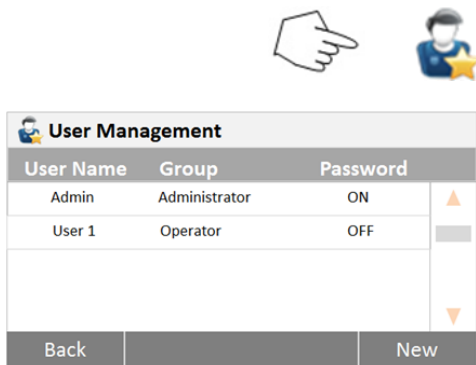

Press User Management button to access User management menu.

Press **User Information** to edit related settings.  
 Press **Back** to return to previous step.  
 Press **New** button to create a new account.

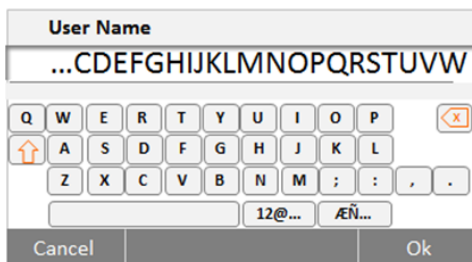

Key in the user name and press **OK** to save.  
 Press **Cancel** to return to previous step without saving.

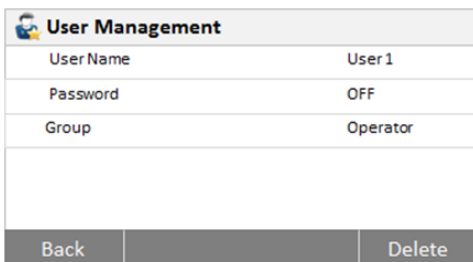

Press **Password** to set the password.



Press the **ON** button to enable the password.

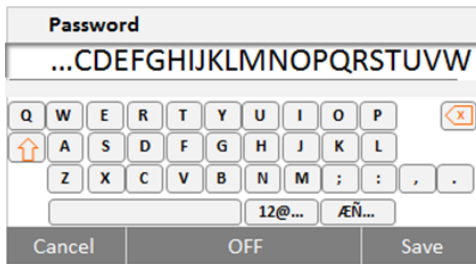

Set the password.  
 Press **OK** to key in the password one more time to confirm.  
 Press **Cancel** to exit the password settings without saving.  
 Press **OFF** to disable the password.



Press **Group** to access group settings.  
 Three groups are available. The group with all access rights is administrator. The administrator group cannot be edited or deleted. All other groups can be edited or deleted.

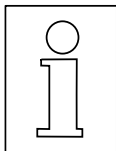

**If the password has been lost, please contact your nearest OHAUS dealer for further assistance.**

### 6.4.2 Login and logout

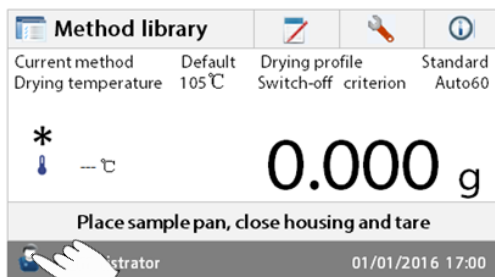

Press the  icon to access the logout screen.

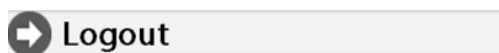

Press **OK** to logout.

Logout Administrator ?



Press the user account to login.



Press **User 1** to switch to other user account.  
Press **Login** to login

## 6.5 System and data management

### 6.5.1 Export and import settings and methods

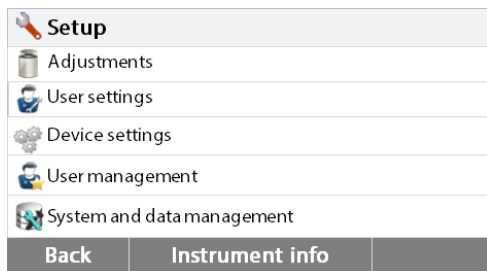

Press the **Setup** button to access Setup menu.

Press **Back** to return to Home screen.

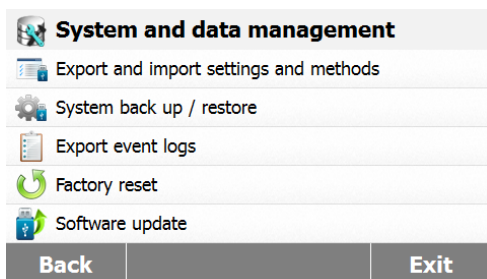

Press the **System and data management** button to access the System and data management menu.

Press **Back** to return to previous step.  
Press **Exit** to return to Home screen.



#### 6.5.1.1 Export data

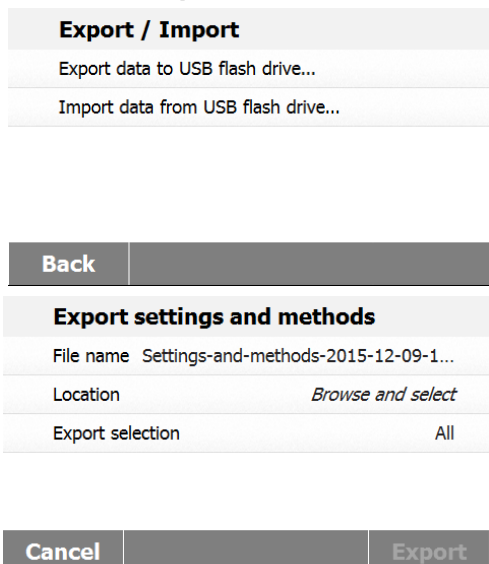

Press **Export and import settings and methods** to access the export and import menu.

Press **Export data to USB flash drive** to select location and export data to USB drive.  
Press **Back** to previous step.  
Press **Exit** to return to Home screen.

Press **File name** to change file name.  
Press **Location** to select the export location.  
Press **Export selection** to select the export items.  
Press **Cancel** to previous step.



Export selection	
<input checked="" type="checkbox"/>	User management
<input checked="" type="checkbox"/>	Methods (1)

Cancel	OK
--------	----

Press the items to select.  
 Press **Cancel** to cancel data export.  
 Press **OK** to confirm and back to previous step.

Export settings and methods	
File name	Settings-and-methods-2015-12-09-1...
Location	C:/IDE
Export selection	All

Cancel	Export
--------	--------

After selecting the location, the **Export** button is available.  
 Press **Cancel** to cancel data export.  
 Press **Export** to execute.

### 6.5.1.2 Import data

Export / Import	
<input type="checkbox"/>	Export data to USB flash drive...
<input type="checkbox"/>	Import data from USB flash drive...

Back
------

Press **Import data from USB flash drive** to select location and import data from USB drive.  
 Press **Back** to previous step.

Import settings and methods	
Import from file	<i>Browse and select</i>

Press **Import from file** to select the file to import.  
 Press **Cancel** to cancel data import.

Cancel	Import
--------	--------

Import settings and methods	
Import from file	Settings-and-methods-2015-12...
Location	E:/
Import selection	All (1)

After selecting the import file, the **Import** button is available.  
 Press **Cancel** to cancel data import.  
 Press **Import** to execute.

Cancel	Import
--------	--------

## 6.5.2 Backup and restore



Press **Backup and restore** to backup or restore the system settings.

### 6.5.2.1 Backup system

Back up / Restore	
Back up system on USB flash drive...	
Restore system from selected back up...	
<b>Back</b>	

Press **Backup system on USB flash drive** to back up the system.

Press **Back** to previous step.

Press **Back** to return to previous step.

Back up	
File name	Backup-2015-12-09-20-45
Location	<i>Browse and select</i>

Press **File name** to change the file name.

Press **Location** to select the backup location.

Press **Cancel** to cancel the backup.

<b>Cancel</b>		<b>Backup</b>
---------------	--	---------------

After selecting the backup location, the

**Backup** button is available

Press **Cancel** to cancel the backup.

Press **Backup** to execute.

Back up	
File name	Backup-2015-12-09-20-53
Location	C:/IDE

<b>Cancel</b>		<b>Backup</b>
---------------	--	---------------

### 6.5.2.2 Restore system

Back up / Restore	
Back up system on USB flash drive...	
Restore system from selected back up...	
<b>Back</b>	

Press **Restore system** from selected back up to restore system.

Press **Back** to previous step.

Restore	
Restore from file	<i>Browse and select</i>

Press **Restore from file** to select the restore file.

Press **Cancel** to cancel the restore.

<b>Cancel</b>		<b>Restore</b>
---------------	--	----------------

Restore	
Restore from file	Backup-2015-12-09-21-05
Location	E:/Backup-2015-12-09-21-05

Cancel	Restore
--------	---------

After select the restore file, the **Restore** button is available.  
 Press **Cancel** to cancel the restore process.  
 Press **Restore** to execute.

### 6.5.3 Export event logs



Export event logs	
File name	Events-2015-12-09-17-54
Location	<i>Browse and select</i>

Cancel	Export
--------	--------

Press **Export event logs** to access the export event logs menu.

Press **File name** to change file name.  
 Press **Location** to select the export location.  
 Press **Cancel** back to previous step.

Export event logs	
File name	Events-2015-12-09-17-54
Location	C:/IDE

Cancel	Export
--------	--------

After selecting the export location, the **Export** button is available.  
 Press **Cancel** to cancel export.  
 Press **Export** to execute.

### 6.5.4 Factory reset



Reset
Factory reset will revert all the changes to factory settings.

  

Cancel	Reset
--------	-------

Press the **Factory reset** button to reset to factory default settings.

Press **Cancel** to return to previous screen without resetting.  
 Press **Reset** to perform a reset.

**CAUTION:**  
 All methods, test results and user account will be deleted when performing a reset!

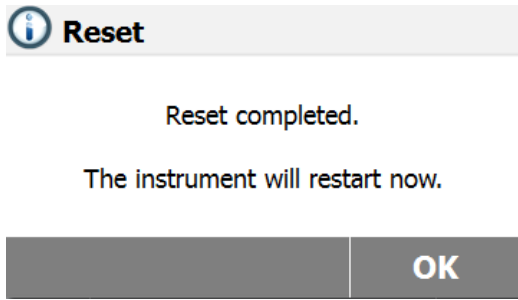

After factory reset, press **OK** to restart the instrument.

### 6.5.5 Software update

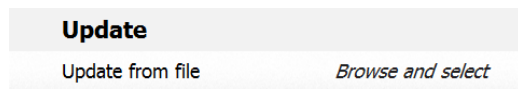

Press **Software update** to access the update software screen.

Press **update from file** to select the update file.

Press **Cancel** to return to previous screen.

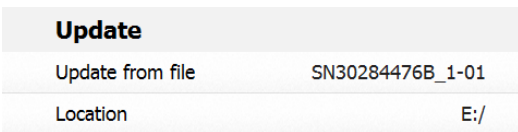

After select the update file, the **Update** button is available.

Press **Update** to execute.



## 7. METHOD LIBRARY

This section contains information on the use of the Method Library which will enable you to set the actual drying parameters such as Profile, Switch-Off, Display, Target Weight and the use of the library.

### The Operating Concept

You have already set the Moisture Analyzer setup in Section 5 and have tried the simple moisture determination in Section 3. You are now ready to perform moisture determinations in a precise manner. The test menu shown in Section 6 offers a number of setting possibilities to match the measurement process to your specific requirements. For instance, you can select the drying temperature, type of display and many other parameters.

Please keep in mind the importance of preparing your sample, the distribution of the sample on the weighing pan, the type of sample and the temperature range. Remember, the greater the number of uniform samples tested, the greater the accuracy of the results.

Please review this entire section before actually making any settings to become familiar with the instrument.

### 7.1 Method load, edit and delete.

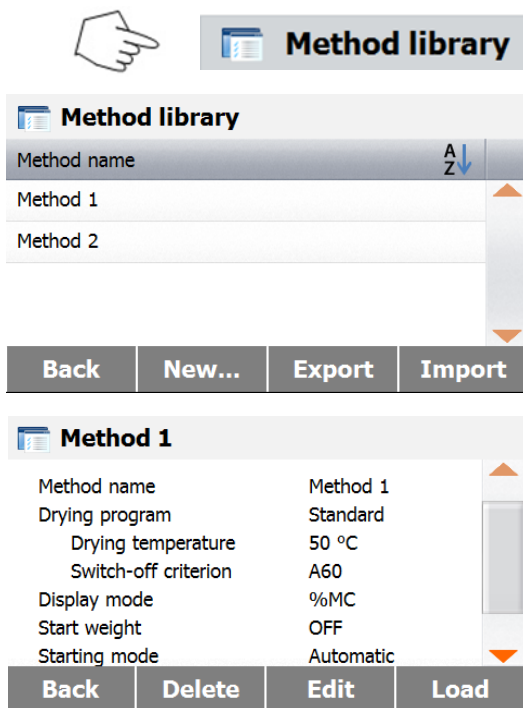

Press Method library in Home screen.

Press method name to check method settings and load to current method.

Press **A Z** to filter the method name.

Press **Back** to Home screen.

Press **New** to create a new method.

Press **Export** to export methods.

Press **Import** to import methods.

Enter the **Method 1** to check the settings.

Press **Back** to previous screen.

Press **Delete** to delete this method.

Press **Edit** to edit method settings.

Press **Load** to load this method as current method.

### 7.2 Entering Method Name



Press Method Library on the Home screen.  
The method library is displayed.

Complete information on how to use the library is covered in this section.

Press the **New** button to start a new test.  
The screen will change to key in the new method name.

**New method name**

1 ... 30 characters 0

Q W E R T Y U I O P

↑ A S D F G H J K L

Z X C V B N M ; : , .

12@... €Öñ...

Cancel OK

Enter either a method name or identifying number and press the **OK** button.

### 7.3 Setting the Drying Profile

The drying profile contains four settings, Standard, Fast, Ramp and Steps. This section describes each of the drying profiles. Review the profile descriptions. Depending upon the sample material to be analyzed, select the appropriate profile and proceed as follows:

Method 1	
Method name	Method 1
Drying program	Standard
Drying temperature	105 °C
Switch-off criterion	10:00 min
Display mode	%MC
Back	

Press the **Drying program** button.  
**Standard Profile**

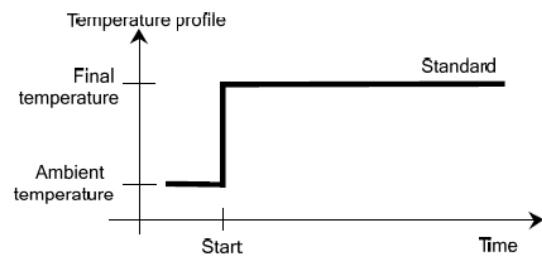

**Fast Profile**

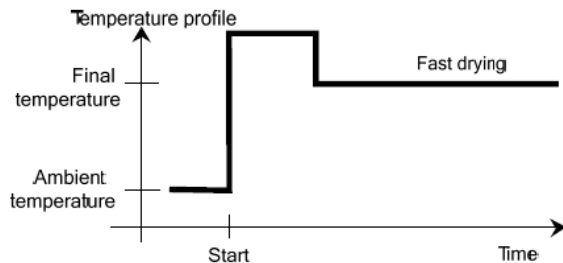

Drying profile			
Standard	Fast	Ramp	Steps
Back			

**Ramp Profile**

For this temperature program, the temperature and time elapsed between the start of drying and the attainment of the final temperature is set.

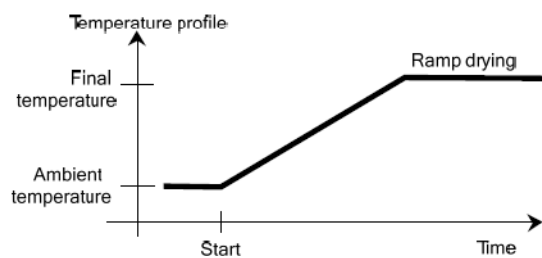

### Step Profile

For STEP 1, use the defined temperature and time.

Repeat the above procedure for step 2 and Final step.

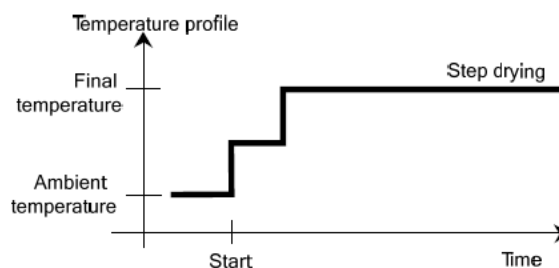

## 7.4 Setting the Drying Temperature

The drying temperature can be set from 40 °C to 230 °C.

Method 1	
Method name	Method 1
Drying program	Standard
Drying temperature	105 °C
Switch-off criterion	10:00 min
Display mode	%MC
<b>Back</b>	

Press the **Drying Temperature** button to access the temperature setting menu.

Temperature in °C	
120	
40-230	
1	2
4	5
7	8
0	↩
Cancel	Ok

Enter the desired drying temperature and press the **OK** button.

**Attention:** If you are working at temperatures above 200 °C, we advise you to wait 2 to 3 minutes to open the instrument lid between individual measurements to ensure good reproducibility and avoid overheating of the instrument.

## 7.5 Selecting the switch-off criterion

This menu offers you different switch-off criterion. Switch-off criterion defines when the instrument should end the drying. Switch-off criterion eliminates checking your watch or clock and stopping the drying manually. Review the list below and select one criterion that suits your purpose.

The following settings can be selected for the switch-off criterion:

- Timed switch-off
- Auto switch-off (weight loss per unit of time - 3 settings)
- Auto free switch-off (user-defined mean weight loss per unit of time)
- Auto free switch-off (user-defined mean moisture % loss per unit of time)

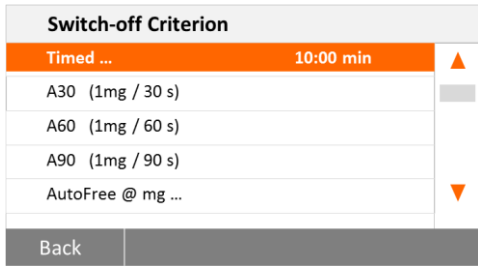

**Timed switch-off**

With this switch-off criterion selected, the measurement lasts until the preset drying time has elapsed (the display provides you with continuous information on the drying time).

Using the +/- buttons, enter the desired drying time and press the OK button.

**Auto switch-off**

The switch-off criterion is based on a **weight loss per unit of time**. As soon as the mean weight loss is less than a preset value during a specified time, the instrument considers drying as complete and automatically discontinues the measurement process. During drying, the display indicates the elapsed time of the drying process; the switch-off criterion is inactive during the first 30 seconds.

The automatic switch-off criterion is divided into three selectable levels:

- A30: Less than 1mg loss in 30 seconds, used for samples which dry very quickly (surface moisture) or for (relatively inaccurate) fast measurements to determine a trend.
- A60: Less than 1mg loss in 60 seconds, used for most types of samples.
- A90: Less than 1mg loss in 90 seconds, used for slow drying substances (trapped moisture, skin formation).

Select the criterion for your measurements.

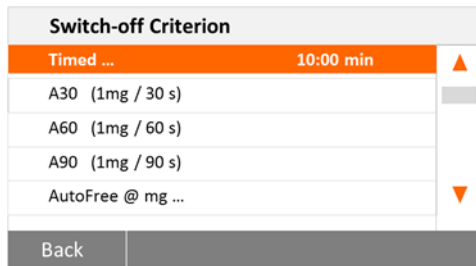

Select A30 (1mg/30s), A60 (1mg/60s) or A90 (1mg/90s).

**Auto free switch-off**

Auto free switch-off criterion are based on a user defined mean weight loss per unit of time or mean weight in percent per unit of time. If none of the three switch-off criteria “Weight loss per unit of time” is suitable for your application, the Moisture Analyzer allows you to define a free switch-off criterion. The free switch-off criterion are based on the principle of the mean weight loss per unit of time and mean weight loss in percent per unit of time. As soon as this drops below the preset value, the measurement is automatically ended.

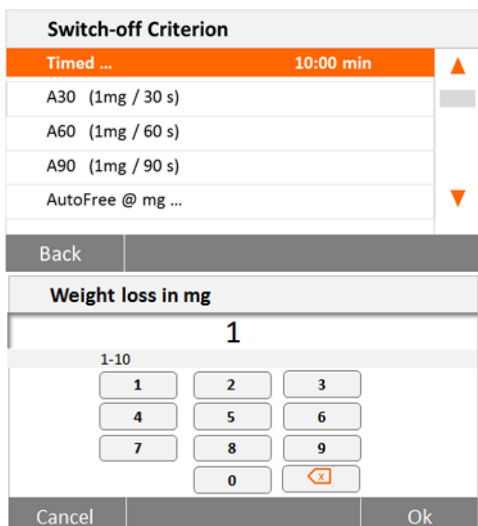

Select AutoFree mean weight loss per unit of time or weight loss in percent per unit of time.

AutoFree (mg/s)

Enter the weight loss (1mg to 10mg).



The screenshot shows a numeric keypad interface for entering time in seconds. The title is 'Time in s'. The current value is 60. Below the display, the range '5-300' is indicated. The keypad contains buttons for digits 1-9, 0, and a delete key (X). At the bottom, there are 'Cancel' and 'Ok' buttons.

Enter the time (5 seconds to 300 seconds).

The screenshot shows a numeric keypad interface for entering weight loss percentage. The title is 'Weight loss in %'. The current value is 0.01. Below the display, the range '0.01-5.00' is indicated. The keypad contains buttons for digits 1-9, a decimal point, 0, and a delete key (X). At the bottom, there are 'Cancel' and 'Ok' buttons.

AutoFree (%/s)  
Enter the weight loss (0.01% to 5.00%).

This is an identical screenshot to the one above, showing the 'Time in s' input screen with the value 60.

Enter the time (5 seconds to 300 seconds).

### 7.6 Displayed result

Displayed result offers you the choice of whether your display indicates % MC, % DC, % RG or grams during the measurement process.

The screenshot shows the 'Method 1' settings screen. It lists several parameters: 'Drying temperature' at 105 °C, 'Switch-off criterion' at 10:00 min, 'Display mode' at %MC, 'Target weight' at OFF, and 'Starting mode' at Automatic. A 'Back' button is at the bottom.

Press the Displayed result button.

The screenshot shows the 'Display Result' selection screen. It is a list with four options: %MC, %DC, %RG, and g. The %MC option is currently selected and highlighted in orange. A 'Back' button is at the bottom.

Select %MC, %DC, %RG or g.

$$\%MC(\text{Moisture Content}) = \frac{\text{Initial weight} - \text{Final weight}}{\text{Initial weight}} \times 100\%$$

$$\%DC(\text{Solids Content}) = \frac{\text{Final weight}}{\text{Initial weight}} \times 100\%$$

$$\%RG(\text{Regain Content}) = \frac{\text{Initial weight} - \text{Final weight}}{\text{Final weight}} \times 100\%$$

## 7.7 Target Weight

Target weight is used when previous samples have been tested and the target weight is known. A consistent sample size is required when using Target Weight.

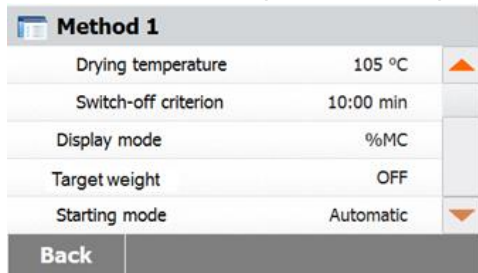

Select the Target Weight.

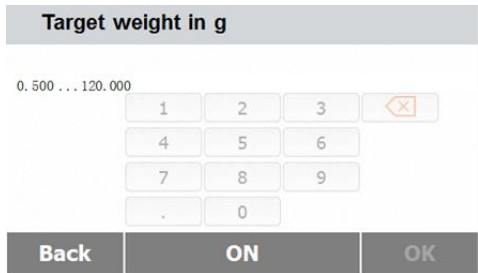

Enable the Target weight and press the **ON** button.



Set the Target weight and press the **OK** button.

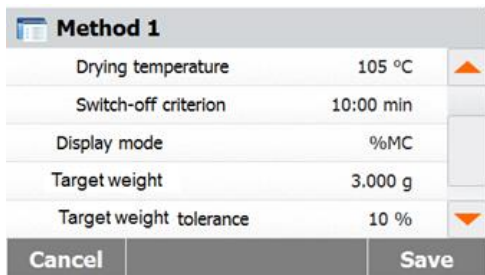

Press **Target weight tolerance** to set the tolerance of the Target weight.

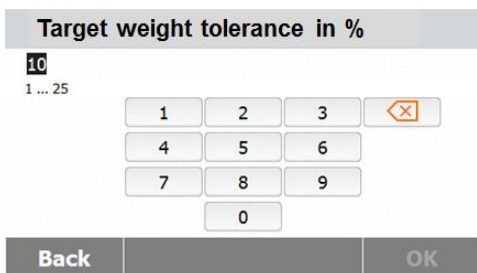

Set the Target weight tolerance in %.

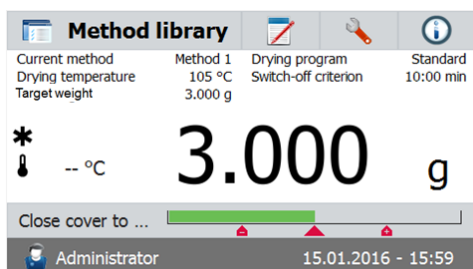

The check weighing bar indicates the sample weight.

## 7.8 Starting Mode

In this menu you can define if the instrument should perform certain functions automatically or manually.

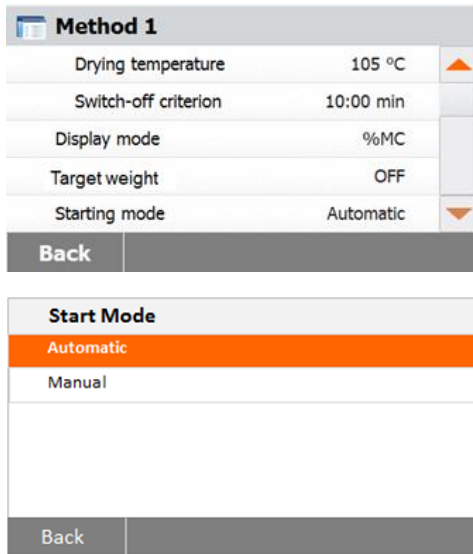

Press the **Starting mode** button.

### Automatic

This mode can be used for most kinds of samples. When closing the sample chamber, the weight of the sample is recorded and the measurement starts. It is the factory default setting.

### Manual

We advise you to use the manual operating mode for samples which contain readily volatile substances. In contrast to the automatic operating mode, in the manual operating mode the sample chamber does not automatically close when the Start/Stop button is tapped. However, the initial weight important for the determination of the moisture content is recorded. In the manual operating mode you have time for further preparation of the sample while weight losses due to evaporation during the preparation time are measured from the outset. As soon as the sample is ready for drying, close the sample chamber. As soon as the automatic sample chamber is closed, drying starts. In the manual operating mode you can open the sample chamber during a drying operation. In contrast to the automatic mode, drying will not be stopped but simply interrupted until the automatic sample chamber is closed again.

## 7.9 Default method

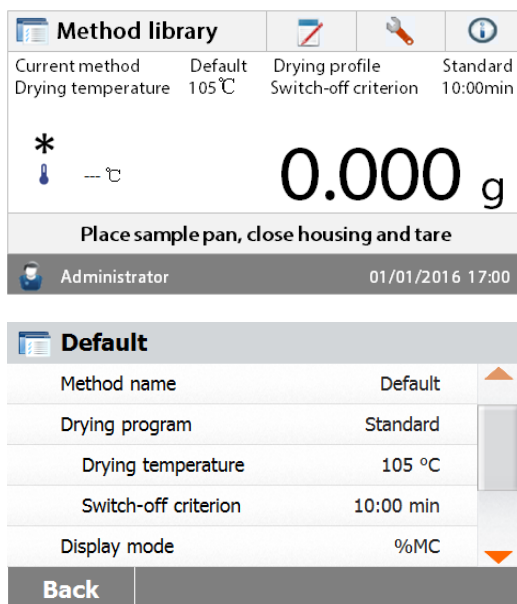

The analyzer comes with a default method preinstalled.

Follow the instruction message to start a measurement directly.

Press parameters area to edit.

Default	
Method name	Default
Drying program	Standard
Drying temperature	120 °C
Switch-off criterion	10:00 min
Display mode	%MC
<b>Cancel</b>	<b>Save</b>

After change the settings, the **Save** button available.  
Press **Save** to save to default method.

### 7.10 Method export and import.

Method library
----------------

Press **Export** to export methods.

Method library			
Method name	A Z		
Method 1			
Method 2			
<b>Back</b>	<b>New...</b>	<b>Export</b>	<b>Import</b>

Export methods	
File name	Methods-2015-12-10-09-39
Location	<i>Browse and select</i>
Export selection	All (3)

Press **File name** to change export file name.  
Press **Location** to select the export location.  
Press **Export selection** to select methods to export.  
Press **Cancel** to return to previous screen.

<b>Cancel</b>	<b>Export</b>
---------------	---------------

Export methods	
File name	Methods-2015-12-10-10-20
Location	E:/
Export selection	All (3)

After selecting the export location and methods, the **Export** button is available.  
Press **Export** to execute.

<b>Cancel</b>	<b>Export</b>
---------------	---------------

Press **Import** to import methods.

Method library			
Method name	A Z		
Method 1			
Method 2			
<b>Back</b>	<b>New...</b>	<b>Export</b>	<b>Import</b>

Import methods	
Import from file	<i>Browse and select</i>

Press **Import from file** to select the file to import.  
Press **Cancel** to previous screen.

<b>Cancel</b>	<b>Import</b>
---------------	---------------

Import methods	
Import from file	Methods-2015-12-10-10-25
Location	E:/
Import selection	All (2)

After selecting the import file, the **Import** button is available.

Press **Location** to change the import location.

Press **Import selection** to select methods to import.

Press **Cancel** to return to previous screen.

<b>Cancel</b>	<b>Import</b>
---------------	---------------

## 8. RESULTS

This section contains the management and evaluation of measurement results.

### 8.1 Test Results



Press the **Results** button on the Home screen to access the results menu.

Results	
Method name	A Z ↓
Method 1	▲
Method 2	▼
<b>Back</b>	

Select the method name to list all the test results of the method.

Press  to filter the method name.

Press **Back** to return to Home screen.

#### 8.1.1 Result data and curve

Method 1		
10.12.2015 - 14:27	10.00 %MC	▲
10.12.2015 - 14:00	10.06 %MC	▼
<b>Back</b> <b>Delete</b> <b>Export</b> <b>Statistics</b>		

Press result item to access the detail data.

Press **Back** to return to previous step.

Press **Delete** to delete the results.

Press **Export** to export these results.

Press **Statistics** to access statistics menu.

Method 1		
User Name	Administrator	▲
Initial weight	3.500 g	
Elapsed time	10:00 min	
Final weight	3.150 g	
Final result	10.00 %MC	
10.12.2015 - 14:27		▼
<b>Back</b> <b>Delete</b> <b>Export</b> <b>Curve</b>		

Press **Back** to return to previous step.

Press **Delete** to delete current result.

Press **Export** to export current result.

Press **Curve** to show result curve.

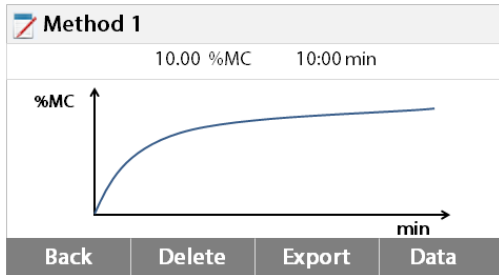

Press **Back** to return to results list.  
 Press **Delete** to delete current result.  
 Press **Export** to export current result.  
 Press **Data** to show detailed result data.

**8.1.2 Statistics**

Method 1		
10.12.2015- 14:27	10.00 %MC	▲
10.12.2015- 14:00	10.06 %MC	▼

Buttons: Back, Delete, Export, Statistics

Select the method name to list all the test results of the method.  
 Press **Statistics** to access statistics menu.

Result selection		
Custom selection of "All" (0)		
<input type="checkbox"/>	10.12.2015- 14:27 10.00 %MC	▲
<input type="checkbox"/>	10.12.2015- 14:00 10.06 %MC	▼

Buttons: Cancel, OK

Press result item to select.

Press  to select all items.

Press **Cancel** to return to previous step.

Result selection		
"All" ( 2)		
<input checked="" type="checkbox"/>	10.12.2015- 14:27 10.00 %MC	▲
<input checked="" type="checkbox"/>	10.12.2015- 14:00 10.06 %MC	▼

Buttons: Cancel, OK

After select the items, the OK button is available.

Press result item to remove.

Press  to remove all items.

Press **Cancel** back to previous step.  
 Press **OK** to execute.

Statistics	
Sample number	2
Last data	10.00 %MC
Mean X	10.03 %MC
Standard deviation	0.04%
Min X	10.00 %MC
Max X	10.06 %MC

Buttons: Back

**8.1.3 Result export**

Method 1		
10.12.2015- 14:27	10.00 %MC	▲
10.12.2015- 14:00	10.06 %MC	▼

Buttons: Back, Delete, Export, Statistics

Press **Export** to export all the results.

Export results	
File name prefix	Method 1
Location	<i>Browse and select</i>
Export selection	"All" ( 2 )
Cancel	Export

Press **File name prefix** to edit file name.  
 Press **Location** to select export location.  
 Press **Export selection** to select export results.  
 Press **Cancel** to return to previous step.

Export results	
File name prefix	Method 1
Location	<i>Browse and select</i>
Export selection	"All" ( 2 )
Cancel	Export

After select the export location, the **Export** button is available.  
 Press **Cancel** to previous step.  
 Press **Export** to export results.

Method 1		
10.12.2015 - 14:27	10.00 %MC	▲
10.12.2015 - 14:00	10.06 %MC	
▼		
Back	Delete	Export
Statistics		

Press result item to check one result data and export it.

Method 1		
User Name	Administrator	▲
Initial weight	3.500 g	
Elapsed time	10:00 min	
Final weight	3.150 g	
Final result	10.00 %MC	
10.12.2015 - 14:27		▼
Back	Delete	Export
Curve		

Press **Export** to export this result.

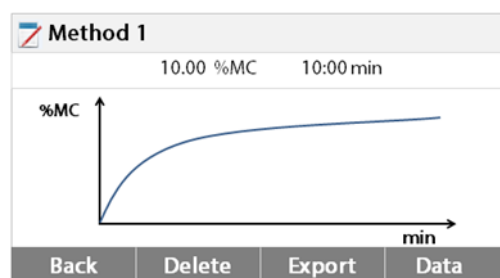

Press **Export** to export this result.

Export results	
File name	Method 1-2015-12-10-15-40
Location	<i>Browse and select</i>
Cancel	Export

Press **File name** to edit file name.  
 Press **Location** to select export location.  
 Press **Cancel** to return to previous step.

Export results	
File name	Method 1-2015-12-10-15-40
Location	<i>Browse and select</i>
Cancel	Export

After selecting the export location, the Export button is available.

Press **Cancel** to previous step.

Press **Export** to the export result.

## 9. HOW TO OBTAIN THE BEST RESULTS

Following your first practical work with the Moisture Analyzer, in this section you will find important information on how to obtain optimum results. You will learn what parameters influence the measurement process and how you can match the instrument optimally to your particular measurement test.

### 9.1 Measurement principle of the Halogen Moisture Analyzer

Your instrument performs measurements based on the thermogravimetric principle, i.e. the moisture is determined from the weight loss of a sample dried by heating.

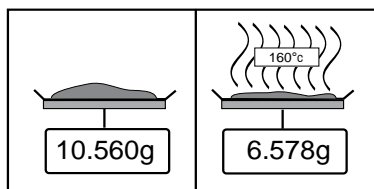

The Ohaus Moisture Analyzer comprises two instruments: a precision balance and a dryer unit. In contrast to other thermogravimetric methods (drying oven, infrared, microwave), the Halogen Moisture Analyzer operates with a halogen dryer unit. This ensures fast heating of the sample and thus guarantees rapid availability of the measurement results.

In addition to thermogravimetric methods, chemical and electrical methods for moisture determination are also common. A familiar chemical method is Karl Fischer in which the water content is determined by titration. This method is particularly suitable for determination of the water content of liquids or for the detection of very small amounts of water (ppm range) in solid and liquid samples.

Regardless of the measurement method used, the quality of the measurement stands or falls by the preparation of the sample and a correct choice of the important measurement parameters:

- Sample size
- Type of sample
- Drying temperature
- Drying time

In practice, however, not only the quality of the measurement results, but also the speed of the measurement process is important. Thanks to its drying principle (with the heat generated by a halogen radiator), the Halogen Moisture Analyzer is very fast. The drying speed can even be increased further through optimum settings of the instrument.

The optimum drying temperature and the drying time are dependent upon the nature and size of the sample and the desired accuracy of the measurement results. These can be determined only by experiment.



## 9.2 Sampling and sample preparation

Characteristics, preparation and size of the sample are all important contributing factors in increasing speed and the quality of the measurement process.

Sampling and the sample preparation have a great influence on the reproducibility of the measured results. It is also important that the sample being investigated is a representative part of the total amount of the sample under test.

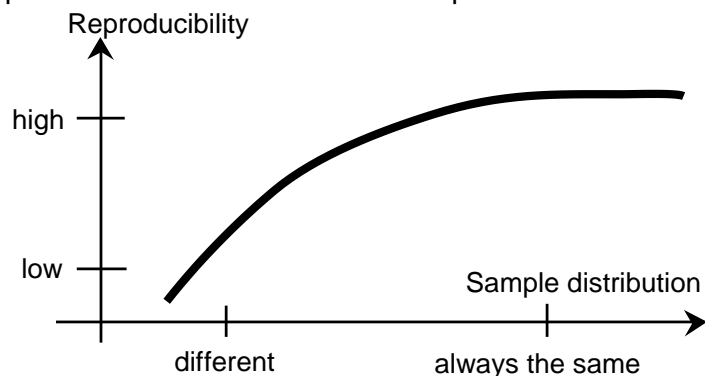

The final results of a moisture determination depends on a carefully thought out sample preparation. The part of the sample used for analysis must always be representative of the total quantity. The sample preparation includes work processes such as sampling, sample division, size reduction, homogenization and others. All of these processes should be carried out as quickly as possible and without loss or uptake of moisture.

As with most products, the lab samples are not homogenous. As a result, random sampling will not lead to a representative sample. The appropriate standards and directions must be consulted to determine the method of sampling as this is dependent upon the product, consistency and the amount used.

### Number of samples

An increase in the number of samples always leads to an improvement in the statistical reliability of the analysis results. The size depends on the homogeneity of the test material, the accuracy of the test material, the accuracy of the measurement method and the desired accuracy of the measurement result.

### Mechanical size reduction

Sample division is usually accomplished by specific types of mills influenced by the sample characteristics. Hard, brittle samples are mainly reduced in size by pressure, impact or friction action, whereas, soft and viscoplastic substances can be comminuted only by shearing or cutting action. Whatever the operating principle of a mill may be, for the subsequent moisture determination, there must be no loss of moisture during the milling operation. If this cannot be avoided, it should at least be calculable. The quantitative recovery of the mill chamber should also be simple and complete.

### Use of quartz sand

To ensure an optimum drying process, samples should always have as large an area as possible. Results of substances which form crusts (e.g. glucose syrup) or pasty substances (e.g. butter) can be considerably improved by mixing with quartz sand. Sample pans with a large volume and relatively high walls are needed for this.

### Pasty, fat-containing and melting substances

For pasty, fat containing and melting substances, use of a glass fiber filter is advantageous to increase the surface area of the sample. The glass fiber filter is tared together with the sample pan. The liquid contained in the substance is uniformly and extensively distributed in the interstices between the fibers throughout the available area. The same also applies to

melting fats and fat containing samples. This increase in the surface area results in faster and complete vaporization of the moisture. Pre-drying of the glass fiber filter and storage in a desiccator is necessary only for highly precise measurement results.

### Liquid substances

Liquid substances (e.g. dispersions) often tend to form drops on the sample pan owing to the surface tension of the liquid. This prevents a rapid drying process. The use of a commercial glass fiber filter shortens the drying time by a factor of 2 to 3. The glass fiber filter distributes the liquid sample over a wide area as a result of its absorbent action. Pre-drying of the glass fiber filter and storage in a desiccator is necessary only for highly precise measurement results.

### Skin-forming and temperature sensitive substances

The use of a glass fiber filter can be useful for temperature-sensitive and skin forming substances. In this case, the sample to be dried is covered by the filter and thus receives a “new surface”. This shields the surface of the sample against direct IR radiation. Gentler heating of the samples is based on convection rather than on IR radiation. Experience with this type of preparation has been good; particularly for products containing sugar. Further, the shielding of the sample against direct IR radiation by covering the test substance can make a considerable contribution to improving the reproducibility with temperature sensitive samples.

### Sugar-containing substances

Samples containing a large amount of sugar tend to caramelize on the surface. In such cases, ensure a thin layer is applied. Also select a moderate temperature.

### Sample application on the drying pan

To obtain reproducible results, it is essential to ensure uniform distribution of the sample on the pan. An uneven distribution can result in homogeneous heat distribution in the sample. As a result, the sample could be incompletely dried in the center owing to excessive piling. Thick layers have an adverse effect on the escape of moisture. The resulting lengthening of the measurement time promotes decomposition at the surface of the sample by prolonged heat action.

Film formation on the sample can prevent complete escape of the moisture. With such samples, ensure application of a thin and uniform layer thickness.

With readily volatile samples, rapid application of the sample on the sample pan is advisable, otherwise, moisture can escape before the initial weight is recorded; here, use of the manual operating mode is appropriate.

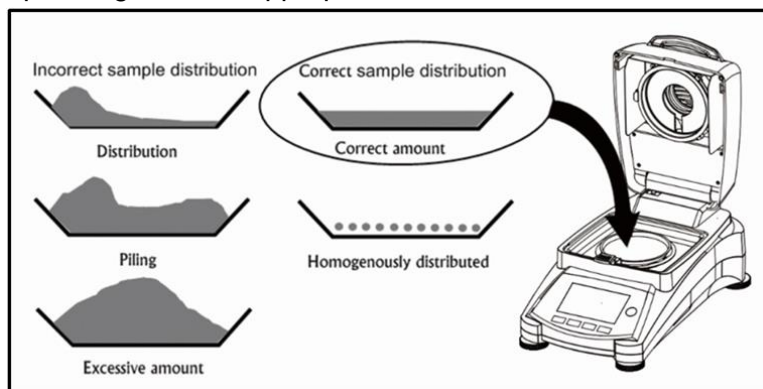

### Treating the sample during drying

Occasionally, following recording of the initial weight of the sample and before the actual drying, the test substance is subjected to further treatment. The halogen Moisture Analyzer from OHAUS offers this possibility in the “manual” operating mode.

Such applications could include:

- Mixing of quartz sand: moisture which vaporizes during the mixing of the sample is correctly taken into account in the final result.
- Coagulation of protein by dropwise addition of alcoholic solutions. This prevents skin formation during drying. Added solvent is not recorded in the final result.
- Formation of readily volatile azeotropes by addition of solvents insoluble in water (e.g. xylene, toluene).



**CAUTION:** Risk of Fire or Explosion.  
Refer to the warning information in section 1.

Note that the addition of solvents can lead to the formation of flammable or even explosive mixtures. With applications of this type, you should thus work with extremely small amounts of samples and with the necessary care. In cases of doubt, a careful risk analysis must be performed.

### Selection of the optimum sample weight

The sample weight has an influence on both the accuracy of the measurement results and the measurement time. With large amounts of samples, a great deal of water must vaporize and the moisture determination takes longer.

To keep the measurement time as short as possible, we advise you choose a low weight for your sample, but not so low that attainment of the required measurement accuracy is no longer possible.

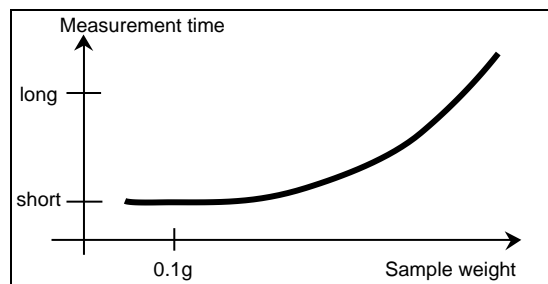
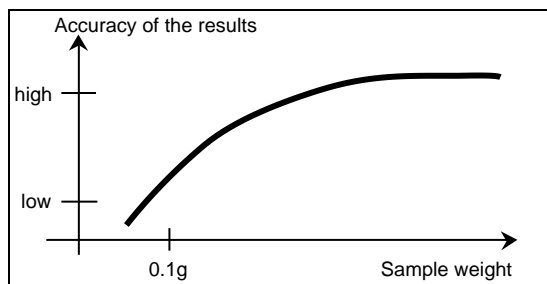

### Influence of the sample weight on the repeatability of the results

Sample weight influences the repeatability of the Moisture Analyzer. The repeatability always becomes worse with decreasing sample weight. The relation between sample weight and repeatability is shown in the following table:

Sample weight	Repeatability
0.5g	±0.6%
1g	±0.3%
2g	±0.15%
5	±0.06%
10g	±0.03%

The preceding table is based on the assumption that the sample is ideal, homogeneous and its moisture can always be separated completely and free from decomposition (e.g. moist sand). Deviations always comprise the uncertainty, which depends on the sample, and the repeatability of the instrument. In practice, measurement differences appearing within a measurement series can consequently be larger than the values of the halogen Moisture Analyzer shown in the table.

The two examples below show how the sample weight is determined to keep the drying time to a minimum and meet the accuracy demands of the instrument.

#### Example 1

The repeatability should be better than  $\pm 0.15\%$ . The accuracy table shows that a sample weight of at least 2g is required to achieve this.

#### Example 2

Wet weight of sample: 10g  
 Mean value of the results: 15.5%  
 Repeatability from the table:  $\pm 0.03\%$   
 Scatter of the measurement results (ideal sample) 15.47% –15.53%

### 9.3 Selection of the drying temperature

The drying temperature exerts a controlling influence on the measurement time. It must be selected so that the sample neither decomposes nor changes its chemical structure. A drying temperature that is too low can unnecessarily prolong the drying time.

Note also that certain samples can give off different amounts of moisture at different drying temperatures. This is the case with substances in which the strength of the bonds binding the moisture varies or those which tend to show signs of decomposition. Minimum deviations from moisture content values of the reference method can be compensated by changing the drying temperature.

The following procedure is suggested for selecting the temperature.

- Estimate moisture content of the sample.
- Determine the decomposition temperature of the sample by experiments.
- Compare the measurement results with the reference method if one exists.
- If an excessive amount of moisture is involved, lower the drying temperature. If the experimental results are too low, the drying temperature was possibly too low or the drying time too short.

With samples which have a high moisture content, it is possible to shorten the measurement time by selection of the step or rapid drying program. Here, the greatest part of the existing moisture is separated at an elevated temperature.

The drying temperature is then lowered and kept constant until the end of drying. The excessive temperature is used for rapid

vaporization of the moisture, but the effective sample temperature does not exceed the boiling temperature of the liquid (cooling effect through endothermic vaporization). In certain cases, local heating and decomposition could still occur at the sample surface.

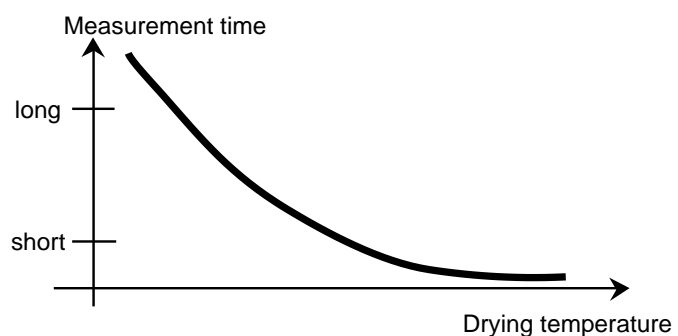

For MB120, OHAUS provides a temperature guide to estimate the proper temperature for reference. Please see section 9.2 for details.

## 9.4 Selection of the drying program

Various drying programs are available in the Halogen Moisture Analyzer. There are four programs which control the temperature profile. They are:

- Standard drying program
- Fast drying program
- Ramp drying program
- Step drying program

### Standard drying

Standard drying is suitable for precise determination of the moisture content of most substances. For special cases or for time optimized measurements, the selection of a more complex drying program may be advantageous.

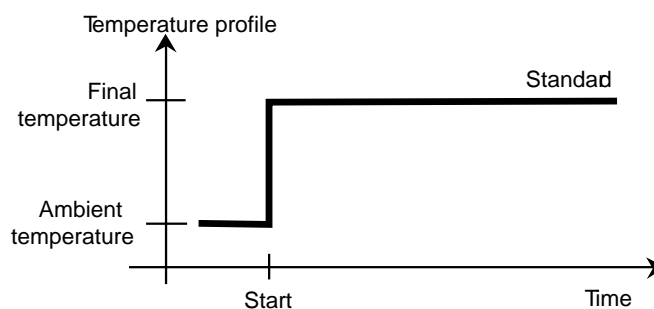

### Ramp drying

Ramp drying is selected if substances are not stable on exposure to the full heating power of the halogen radiator at the start. In ramp drying, sensitive samples are prevented from decomposition by the gentle heating. Ramp drying can also be used successfully with substances which form a skin.

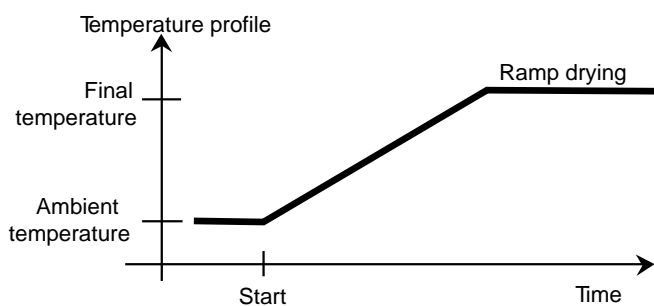

### Fast drying

The fast drying program is suitable for samples with a moisture content between 5% and 15%. In fast drying, the radiator power exceeds the set temperature value during the first minute following the start of drying. This compensates the endothermic heat of vaporization and accelerates the drying process. Note that the sample must contain sufficient moisture during the first minute to cool it.

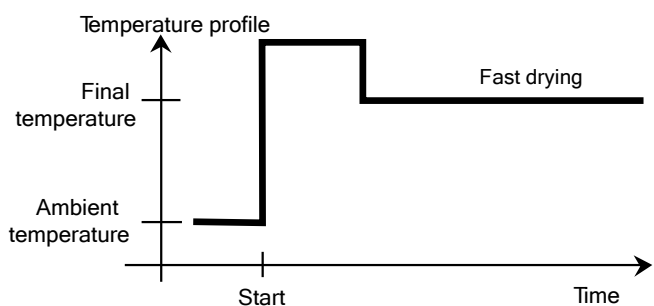

### Step drying

The step drying program has a use similar to that of fast drying. The duration of the excessive temperature stage and the temperature value are freely selectable. It is used primarily with samples with a moisture content greater than 15%.

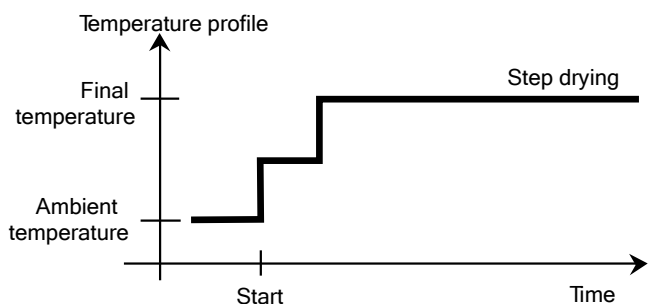

An alternate application possibility lies in the selective determination of the moisture at different temperatures. Gypsum, for example, releases only its surface water at 50°C,

whereas the water of crystallization cannot be separated until 168°C. With this drying program, it is thus possible to determine the surface water and the water of crystallization separately within the same measurement by a controlled temperature profile.

## 9.5 Selection of the drying time

The Halogen Moisture Analyzer offers two different types of switch-off criteria. A switch-off criterion is understood to mean the condition which must be met for the Halogen Moisture Analyzer to switch off automatically and end the drying.

The first type is a timed switch-off. This is used primarily when the drying process does not attain a constant final value and the sample continuously loses mass over time through decomposition or the evolution of difficult to volatilize components.

The second type recognizes the end of drying automatically. The integrated balance continuously determines the weight loss of the sample during drying. If the weight loss per unit of time is less than the set level, the drying is stopped and the final result is displayed.

### Auto Switch Off

The automatic switch-off criterion is divided into three selectable levels:

- **A30:** Less than 1mg loss in 30 seconds, used for rapidly drying substances.
- **A60:** Less than 1mg loss in 60 seconds, used for standard samples.
- **A90:** Less than 1mg loss in 90 seconds, used for slow drying substances (e.g. plastics).

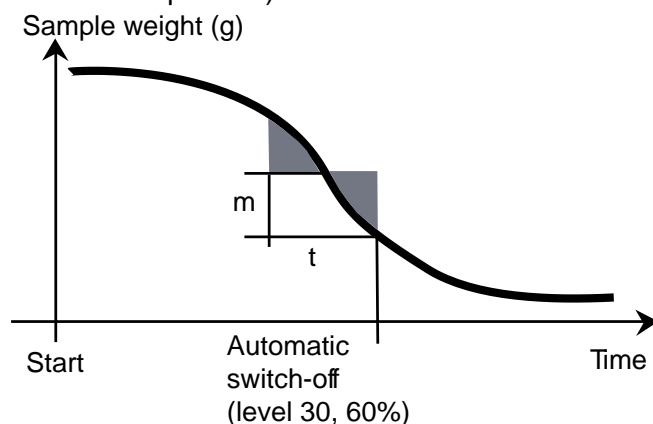

### Auto Free switch-off criterion

The Auto Free switch-off criterion is based on a user defined mean weight loss per unit of time or weight loss in percent per unit of time. As soon as this drops below the preset value, the measurement is automatically ended.

### Manual

With this switch-off criterion, the measurement process continues until you stop it with the STOP button. The elapsed time is shown in the display.

### Timed switch-off

With this switch-off criterion, the measurement lasts until the preset drying time has elapsed.

## 9.6 Analysis of the drying profile

In the first type, the drying profile is asymptotic. The amount of moisture lost assumes a constant value and no longer changes after long drying times. With this drying profile, repeatable determinations of the moisture content are always simple.

The measurement result then corresponds exactly to the constant value of the asymptote. It is also correspondingly easy to find a suitable switch-off criterion.

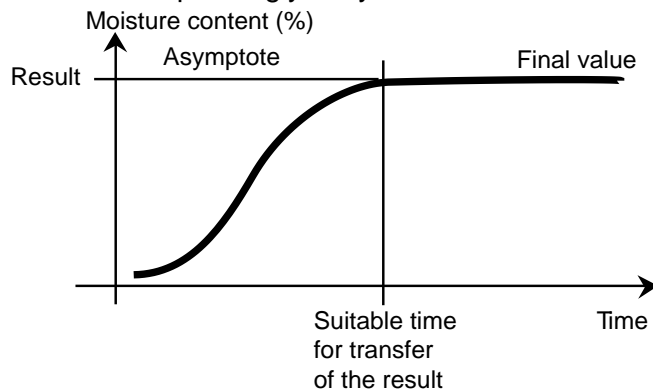

In the second type, drying runs quickly at the start and then flattens out. The moisture content never assumes a constant value. The causes of such a drying profile can be as follows:

The sample exhibits thermal decomposition, the decomposition products vaporize and the sample continuously loses weight. Fats, oils, plasticizers or other volatile components can lead to superimposed profiles owing to their slower vaporization than water. The difficult to volatilize components lead to a slow, continuous decrease in weight.

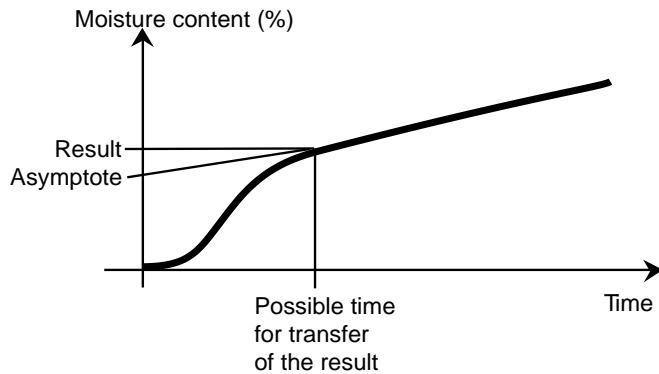

Measurement results of such a drying profile can be optimized:

- Lowering the temperature can slow down the decomposition reaction.
- The selection of a suitable switch-off criterion can allow recognition of the end of the analysis at the desired break point of the drying curve.
- The selection of a constant drying time often provides good measurement results.
- Keep the initial weight of the sample constant ( $\pm 10\%$ .... $\pm 20\%$ ).

## 10. HELP INFORMATION

### 10.1 Level Assist



Press the **Help** button on the Home screen to access the help information menu.

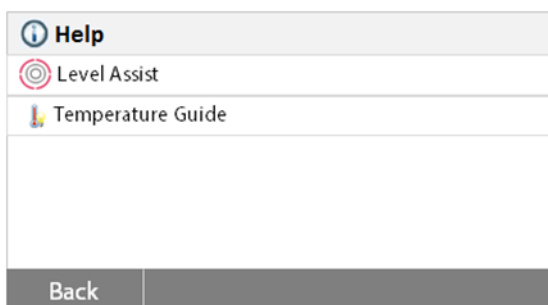

Select **Level Assist** button to access it. Please adjust the level feet accordingly.

Press the screen to exit.

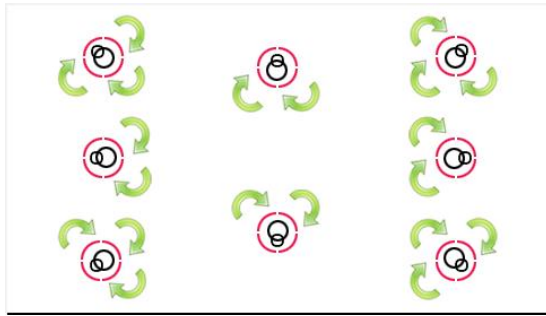

### 10.2 Temperature Guide

This function allows you to estimate the proper temperature for the sample you want to test. After the analysis, it will provide a characteristic curve of the sample and some typical curves will help to define the temperature.



Press the **Help** button on the Home screen to access the help information menu.

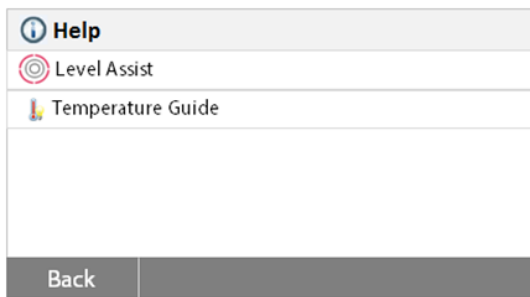

Select **Temperature Guide** to access the temperature guide.

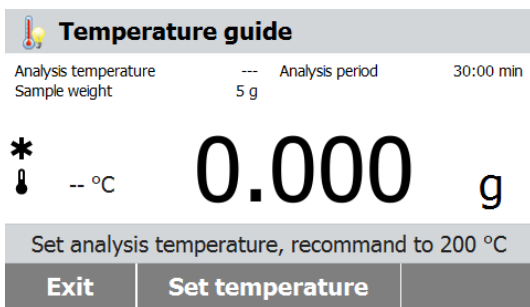

Press the **Set Temperature** button to enter the temperature setting.

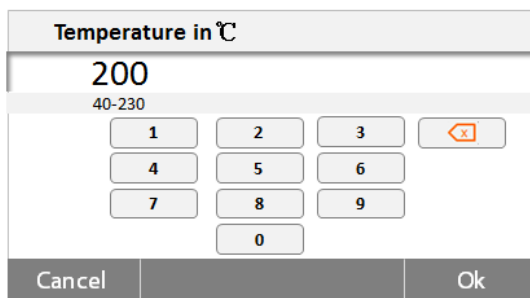

Set the temperature. We recommend to not set it above 200°C. Press the **Ok** button to save the temperature and access to next step.

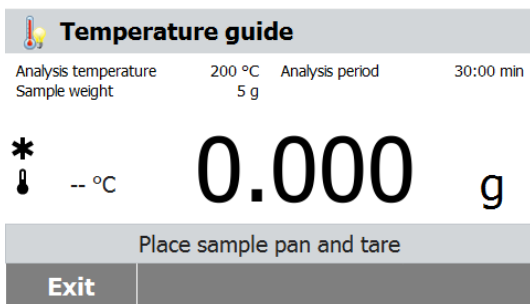

Follow the instructions to place sample pan, close housing and tare.



**Temperature Guide**

Analysis temperature 200°C Analysis period 30:00 min  
 Sample weight 5 g

\*  
 --- °C **5.000** g

Place 5g sample, close housing and start

Exit

Place a 5g sample and start the analysis

**Temperature Guide**

Analysis Temperature 200°C Analysis Period 30:00 min  
 Sample weight 5 g

150 °C  
 10:05 min

Analysis in progress....

Cancel

The analysis will take 30 minutes and the characteristic curve is shown accordingly.

**Temperature Guide**

Analysis is finished.

Exit Temperature Estimate

The analysis will finish with a characteristic curve calibrated by a temperature axis. Press **Temperature Estimate** button to compare the result curve with typical curve guide.

**Temperature Guide - Estimate**

Please estimate the temperature according the analysis results curve. The orange area is the proper temperature range for below sample curves. It's the reference to define the drying temperature of the method.

Back

Press the **Back** button to check the analysis result – curve. Estimate the proper temperature for method development.

## 11. PRINTING TEST DATA

Printing data to an external computer or printer requires the communication parameters be set first.

Printing to an external printer or computer will occur each time the Print button is pressed. If the Print Interval is set in the Test Menu, printing can occur in a continuous fashion at specified intervals.

Samples of weight adjustment, temperature adjustment and test data (GLP on and GLP off) are shown as follows:

### Weight adjustment printout

```

WEIGHT ADJUST EXTERNAL

1.Jan 2016  11:20

Halogen Moisture Analyzer

Type           MB120
SNR(Drying Unit) 1234567
SNR(Terminal)

Weight ID
Nominal Weight      50.000 g
Actual Weight      50.000 g
Difference          0.000 g
Cell Temperature 24.35 °C

Adjustment        Done

Signature:

.....
-----END-----
    
```

### Temperature adjustment printout

```

TEMPERATURE ADJUSTMENT

1.Jan.2016  11:25

Halogen Moisture Analyzer

Type           MB120
SNR(Drying Unit) 1234567
SNR(Terminal)

Temp Kit ID
Temp1 target    100 °C
Temp1 actual    99 °C
Temp2 target    160 °C
Temp2 actual    161 °C

Adjustment      Done

Signature:

[.....]
[-----END-----]
    
```

**Test data printout**

Interval at 30 seconds.

MOISTURE DETERMINATION	
Halogen Moisture Analyzer	
Type	MB120
SNR(Drying Unit)	1234567
SNR(Terminal)	
SW(Drying Unit)	1.20
SW(Terminal)	1.01.01
Method Name	Method 1
Drying Prog	Standard
Drying Temp	105°C
Switch Off	A60(1mg/60s)
Start Weight	3.098 g
00:00 min	0.00%MC
00:30 min	9.17 %MC
01:00 min	12.35 %MC
01:30 min	15.28 %MC
02:00 min	21.94 %MC
05:00 min	29:36 %MC
05:21 min	31.94 %MC
Total Time.	05:21 min
End Result	. 31.94 %MC
Sample ID:	
.....	
Signature:	
.....	
1.Jan.15 15:35	
-----END-----	

**Statistics printout**

--- STATISTICS DATA ---	
Halogen Moisture Analyzer	
Type	MB120
SNR(Drying Unit)	1234567
SNR(Terminal)	
SW(Drying Unit)	1.20
SW(Terminal)	1.01.01
Sample Number	6
Last Data	86.23 %MC
Mean Value	87.01 %MC
Standard Deviation	2.06
Minimum Value	83.47 %MC
Maximum Value	88.98 %MC
Signature:	
.....	
-----END-----	

**Attention:** When printing data to OHAUS SF40A printer, please disable the printer setting "Balance Feature" first.

## 11.1 RS232 Command Table

### Output Formats

Data output can be initiated in one of two ways:

1. By pressing the Print button;
2. Using the Print Interval feature;

### RS232 Commands

All communication is accomplished using standard ASCII format. Only the characters shown in the following table are acknowledged by the Moisture Analyzer. Invalid command response "ES" error indicates the Moisture Analyzer has not recognized the command. Commands sent to the Moisture Analyzer must be terminated with a Line Feed or carriage return-line line feed (CRLF). Data output by the Moisture Analyzer is always terminated with a carriage return-line feed (CRLF).

**RS232 COMMAND TABLE**

Command Character	Description
<b>V</b>	Read SW Version
<b>TIM</b>	Read/Set Current Time
<b>DAT</b>	Read/Set Current Date

## 11.2 RS232 Pin out

The following table illustrates the pin-out connections on the RS232 connector.

1		N/C
2	<-	Date Out (TXD)
3	->	Date Out (RXD)
4&6		N/C
5		Ground
7	->	Clear to send (CTS)
8	<-	Request to send (RTS)
9		N/C

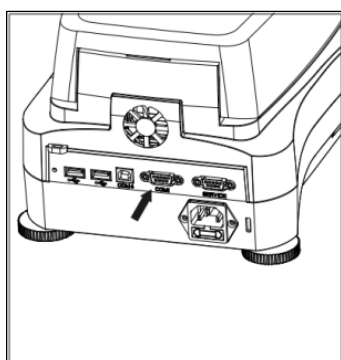

**Attention:** The RS232 port (COM 1) is located near the USB device port.

## 12. CARE AND MAINTENANCE

In this section, you will learn how to keep your Moisture Analyzer in good condition and how to replace consumable parts.

### 12.1 Cleaning Interior/Exterior Components

To continue to obtain precise measurements, it is advisable to clean the interior components at regular intervals. Please note the following instructions for cleaning your instrument.

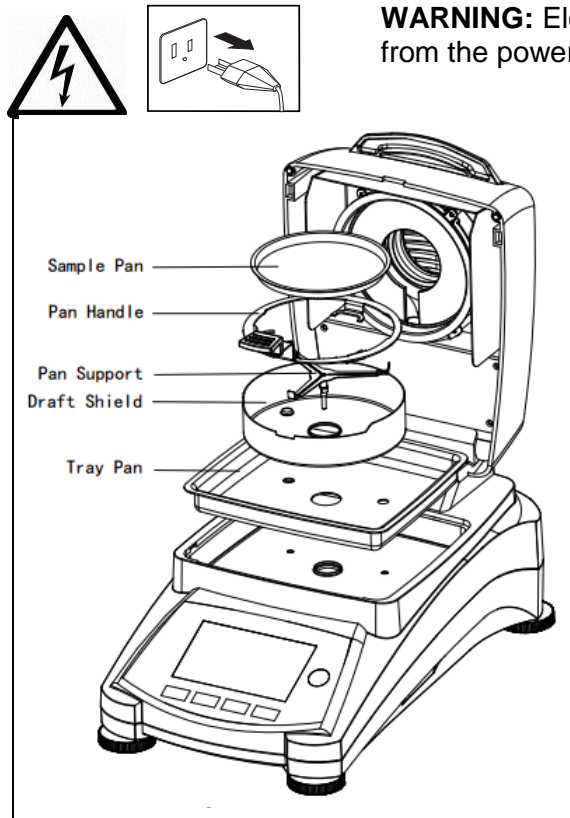

**WARNING:** Electric Shock Hazard. Disconnect the equipment from the power supply before cleaning.

Open the cover and remove the pan handle, sample pan, draft shield, and heat shield from the instrument before cleaning.

Use a lint-free cloth for cleaning.

Clean the exterior of the instrument and the drying compartment components with a mild cleaning agent. Although the housing is extremely rugged and resistant to solvents, never use abrasive cleaning agents or solvents!

Ensure that no liquid enters the interior of the instrument.

Replace the components after cleaning.

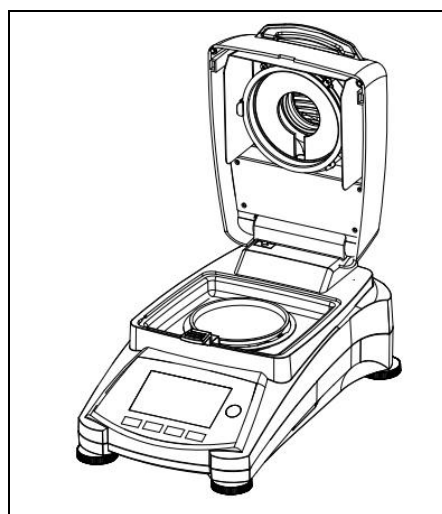

#### Cleaning Temperature Sensor and Protective Glass

Check the protective glass and the temperature sensor for debris which could impede the operation. If the glass appears dirty, clean the surface facing the compartment using a commercial glass cleaner. If the sensor is dirty, clean using a mild cleaning agent.



**WARNING:** Do not spray the glass cleaner directly on the glass. Instead, spray it on a cloth and use the cloth to clean.

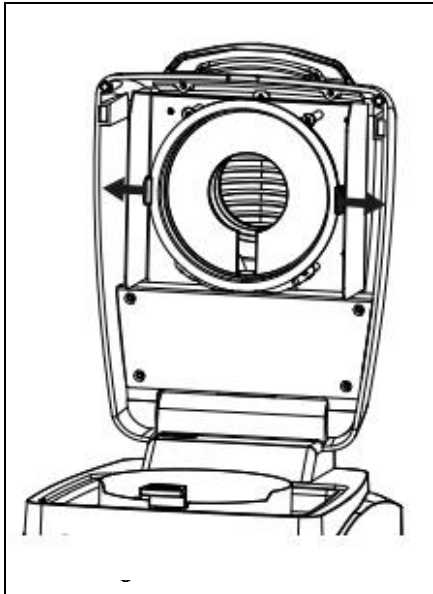

### Removing Glass for Cleaning

If the inside of the glass is dirty, lift up the heating chamber, release the glass for cleaning by pressing both sides of the glass holder.

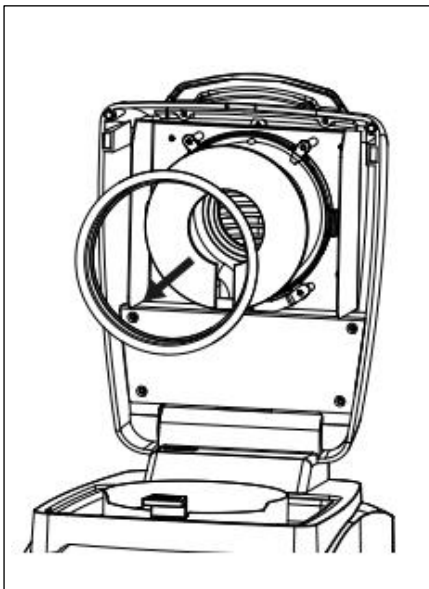

**Attention:** Caution when releasing the glass from the glass holder.

Reassemble after cleaning.



**WARNING:** Do not touch or clean the Halogen heater.

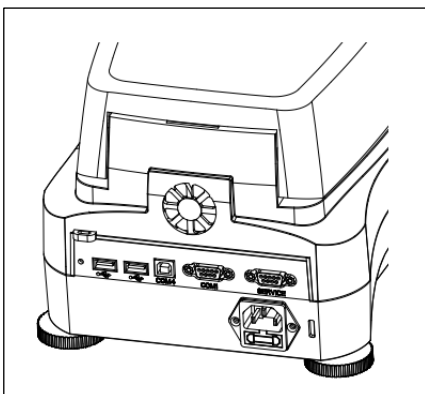

### Cleaning air inlet

The air inlet of the fan is located at the rear of the instrument and its exterior should be cleaned from time to time to free it from any dust deposits.

## 12.2 Replacing Power Line Fuse

If the instrument display fails to light after switching it on, check the power outlet first. If power is available, and the instrument fails to operate, the power fuse may be open (blown).

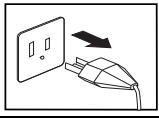
 	<p><b>WARNING:</b> Electric Shock Hazard. Disconnect the equipment from the power supply before cleaning.</p>
---	---

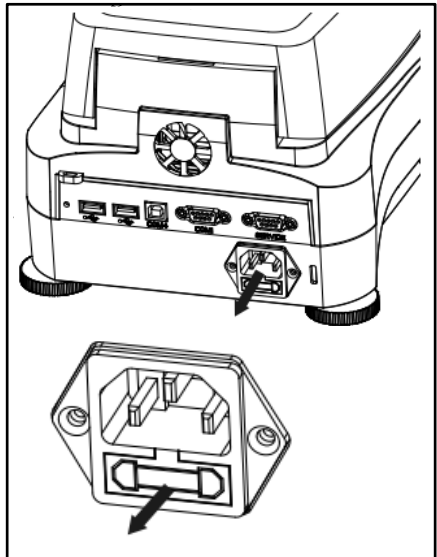

Using a test pen, turn the fuse holder to the left (counterclockwise) and remove the fuse.

Check the condition of the fuse. Replace blown fuse by those of the same type with the same rated value (6.3A 250VAC for 100-120VAC power supply or 2.5A 250VAC for 200-240VAC power supply according to the heating element).

**Attention:** If the fuse is good and power is available at the outlet, the cord or instrument may be defective. Try a new cord. If this does not work, the instrument should be sent back for servicing.



The use of a fuse of a different type or with a different value, or bridging or shunting the fuse is not allowed and can possibly cause a hazard to your safety and lead to instrument damage!

## 12.3 Troubleshooting

Problem: Under load

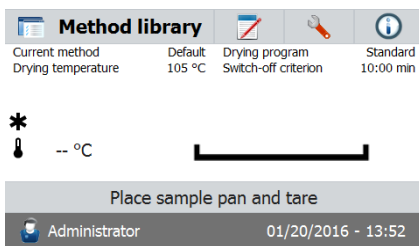

Probable cause:

-No pan support. Put the pan support in the correct position.

Problem: Over load

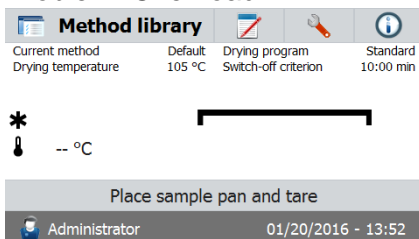

Probable cause:

-Too many samples. Try to remove the sample from the sample pan.

Problem: Display remains dark after switching ON.

Probable causes:

- No line voltage
- Power cable not connected
- Power line fuse blown
- Instrument faulty

Problem: The measurement takes too long.

Probable cause: — You have selected an unsuitable switch-off criterion. Try experimentation to arrive at a suitable switch-off criterion.

Problem: The instrument does not heat following the start up.

Probable cause: — The dryer is overheated and the thermal overload protection has responded. For safe operation, the instrument is equipped with a duplicate overheating protection device: The dryer unit has a thermal overload protection device which switches off the heating element. Contact your OHAUS dealer.

Problem: The measurements are not repeatable.

Probable causes:

- The samples are not homogeneous, i.e. they have different compositions. The more inhomogeneous a sample, the larger the amount of sample needed to obtain a repeatable result.
- You have selected a drying time that is too short. Extend the drying time or select a suitable switch-off criterion "Weight loss per unit of time".
- The sample does not come completely dry (e.g. owing to skin formation). Dry the sample on quartz sand.
- You have selected a temperature that is too high and the sample has oxidized. Lower the drying temperature.
- The sample boils and the splashed drops continuously change the weight. Lower the drying temperature.
- Insufficient heating power as the protective glass is dirty. Clean the protective glass.
- The temperature sensor is contaminated or faulty. Clean the temperature sensor.
- The support on which the instrument is standing is not stable. Use a stable support.
- The surroundings are very unstable (vibrations etc.).

## 12.4 Error detection

The Moisture Analyzer utilizes an audio tone to indicate an error. A *normal* button press or entry results in a short, high pitched tone. When an entry is incorrect or an improper button is pressed, a low pitched tone is emitted. There are no system error codes shown on the displays under these conditions.



## 12.5 Service information

If the Troubleshooting section does not resolve or describe your problem, you will need to contact an authorized Ohaus Service Agent. For Service assistance in the United States, please call Aftermarket, Ohaus Corporation toll-free at (800) 526-0659. An Ohaus Product Service Specialist will be available to help you.

## 12.6 Accessories

Description	Ohaus Part No.
Reusable Sample Pan	80252478
Security Locking Cable	80850043
Printer SF40A	30045641
Sample Pans 90mm diameter	80850086
Glass Fiber Pads	80850087
In-use Cover	30284478
Temperature Calibration Kit	11113857

## 13. TECHNICAL DATA

### 13.1 Admissible ambient conditions

Indoor use only



Altitude:	Up to 4000m
Temperature range:	10 °C to 40 °C
Atmospheric humidity:	Maximum relative humidity 80% for temperatures up to 31 °C decreasing linearly to 50% relative humidity at 40 °C.
Warm-up time:	At least 30 minutes after connecting the instrument to the power supply; when switched on from standby-mode, the instrument is ready for operation immediately.
Voltage fluctuations:	Mains supply voltage fluctuations up to $\pm 10\%$ of the nominal voltage
Over voltage category:	II
Pollution degree:	2
Power load:	Max. 450 W during drying process
Power supply voltage:	100V – 120 VAC 5A 50/60 Hz or 200V – 240 VAC 2.5A 50/60 Hz (depending on the model)
Power line fuse:	6.3A 250 VAC for 100V-120VAC power supply or 2.5A 250VAC for 200V-240VAC power supply according to the heating element.

## 13.2 Specifications

Model	MB120
Capacity	120
Readability	0.01%/0.001g
Repeatability (Std Dev) (g)	0.05% (3g sample) 0.015% (10g sample)
Moisture range	0.01% to 100% (0.01% to 1000% for regain mode)
Heating Element	Halogen
Drying Programs	Standard, Fast, Ramp, Step
Temp range	40° C - 230° C
Switch-off Criteria	Timed, Auto(30, 60, 90 seconds), Autofree mg/s, Autofree %/s, manual
Adjustment	External adjustment mass - 50g
Power	100V – 120 VAC 5A 50/60 Hz or 200V – 240 VAC 2.5A 50/60 Hz
Operating temperature range	50° to 104°F / 10° to 40°C
Display type	4.3', QVGA, TFT touch screen
Display results	%moisture, %solids, %regain, time, temperature, weight, method name, drying curve and statistics
Pan size (mm)	90
Interface	RS232, USB host, USB device,
Adjustable Feet and Level	Yes
Dimensions (WxHxD) (cm)	21x18x35
Net wt. (kg)	5.23
Shipping wt. (kg)	8.35

## 14. COMPLIANCE

Compliance to the following standards is indicated by the corresponding mark on the product.

Marking	Standard
	This product conforms to the EMC directive 2004/108/EC, the Low Voltage Directive 2006/95/EC. The complete Declaration of Conformity is available online at <a href="http://www.ohaus.com">www.ohaus.com</a> .
	AS/NZS 61000.6.1, AS/NZS 61000.6.3
	CAN/CSA C22.2 No. 61010-1, UL Std No. 61010-1

**FCC Note**

This equipment has been tested and found to comply with the limits for a Class A digital device, pursuant to Part 15 of the FCC Rules. These limits are designed to provide reasonable protection against harmful interference when the equipment is operated in a commercial environment. This equipment generates, uses, and can radiate radio frequency energy and, if not installed and used in accordance with the instruction manual, may cause harmful interference to radio communications. Operation of this equipment in a residential area is likely to cause harmful interference in which case the user will be required to correct the interference at his own expense.

Please note that changes or modifications not expressly approved by the party responsible for compliance could void the user's authority to operate the equipment.

**Industry Canada Note**

This Class A digital apparatus complies with Canadian ICES-003.

**ISO 9001 Registration**

In 1994, Ohaus Corporation, USA, was awarded a certificate of registration to ISO 9001 by Bureau Veritas Quality International (BVQI), confirming that the Ohaus quality management system is compliant with the ISO 9001 standard's requirements. On May 21, 2009, Ohaus Corporation, USA, was re-registered to the ISO 9001:2008 standard.

**Disposal**

In conformance with the European Directive 2002/96/EC on Waste Electrical and Electronic Equipment (WEEE) this device may not be disposed of in domestic waste. This also applies to countries outside the EU, per their specific requirements.

The Batteries Directive 2006/66/EC introduces new requirements from September 2008 on removability of batteries from waste equipment in EU Member States. To comply with this Directive, this device has been designed for safe removal of the batteries at end-of-life by a waste treatment facility.

Please dispose of this product in accordance with local regulations at the collecting point specified for electrical and electronic equipment.

If you have any questions, please contact the responsible authority or the distributor from which you purchased this device.

Should this device be passed on to other parties (for private or professional use), the content of this regulation must also be related.

For disposal instructions in Europe, refer to [www.ohaus.com/weee](http://www.ohaus.com/weee)  
Thank you for your contribution to environmental protection.

## A1. APPLICATION EXAMPLES

This appendix includes a table indicating problems specific to various substances and their possible solution. The samples were selected so that representatives of many material classes are considered. For the solution to your specific problem, a substance similar to your sample can be selected from the list.



### APPLICATION DISCLAIMER:

- Moisture determination applications must be optimized and validated by the user according to local regulations. Application specific data provided by Ohaus is provided for reference purposes only.
- Ohaus waives all liability for applications based on this data.

**TABLE A-1 COMPILATION OF APPLICATIONS WITH THE OHAUS MOISTURE ANALYZER**

Method Code	Sample Name	Sample Size	Prep.Method	Heating Profile	Shut-off Criteria	Time	%MC
<b>Dry Food Ingredients</b>							
ZZ1001	Flour	3 g	as is, well mixed	fast, 105°C	A60	5 min	13.10
ZZ1002	Corn meal	3 g	as is, well mixed	fast, 120°C	A60	4:30 min	10.45
ZZ1003	Corn starch	3.5 g	as is, well mixed	standard, 123°C	A60	8 min	12.60
ZZ1004	Breadcrumbs	4 g	as is, well mixed	standard, 135°C	A60	10 min	7.71
ZZ1005	Cocoa powder	3 g	as is, well mixed	standard, 140°C	A60	4:30 min	5.45
ZZ1006	Powdered milk	3g	as is, well mixed	fast, 100°C	Timed	5 min	5.68
ZZ1007	Instant coffee	3 g	as is, well mixed	standard, 154°C	A30	2:30 min	2.56
<b>Finished Baked/Fried Foods</b>							
ZZ2001	Cake	3 g	uniform mix of crumb	step, 140°C 3 min, 110°C 4 min	A30	8 min	19.04
ZZ2002	Cracker	3 g	grind uniform crumb	fast, 76°C	A60	4:30 min	1.42
ZZ2003	Potato chip	3 g	small pieces	standard, 150°C	A30	3 min	1.83
ZZ2004	Roasted peanuts	3 g	grind, 15 sec.	standard, 128°C	Timed	5 min	2.24
<b>Misc. Foods</b>							
ZZ3001	Carrot	3 g	shredded	step, 190°C 3 min, 120°C 3 min	A30	30 min	87.06
ZZ3002	Fruit juice concentrate	3 g	as is	step, 185°C 4min, 145°C	A60	15 min	92.92
ZZ3003	Wet vegetables (spinach)	5 g	small pieces	step, 195°C 7 min, 150°C 1 min, 105°C	A30	30 min	93.74
ZZ3004	Dehydrated vegetables	2 g	as is	fast, 125°C	A30	4 min	7.98
ZZ3005	Dried herbs	1 g	small pieces	standard, 160°C	A30	2:30 min	10.20
ZZ3006	Snack pudding	2 g	sandwich between pads	step, 180°C 3 min, 120°C 3 min	A30	15 min	78.08
ZZ3007	Creamy salad dressing	3 g	spread on glass pad	step, 190°C 3 min, 120°C 7 min	Timed	10 min	23.23
ZZ3008	Lowfat salad dressing	2 g	sandwich between pads	fast, 170°C	1mg/40s	9:30 min	49.66
ZZ3009	Butter	3 g	spread on glass pad	step, 180°C 2min, 130°C	A60	14:30 min	14.81
ZZ3010	Processed cheese	3 g	sandwich between pads	step, 180°C 7min, 170°C	A30	20 min	57.00
ZZ3011	Ketchup	1 g	sandwich between pads	step, 180°C 10min, 120°C 2min	A60	14 min	70.34
ZZ3012	Salt	10 g	as is	standard, 200°C	Timed	4 min	0.05
ZZ3013	Powdered rock candy	5 g	as is	standard, 145°C	A60	1:30 min	0.07
ZZ3014	Brown powdered sugar	5 g	mix with sand	standard, 135°C	A60	15:30 min	6.15
<b>Animal Feed/Grains</b>							
ZZ4001	Pelleted pet food	5 g	grind, 30 sec.	fast, 121°C	Timed	4 min	8.43
ZZ4002	Cracked corn	5 g	grind, 30 sec.	fast, 158°C	Timed	4 min	16.44
ZZ4003	Rye seed	5 g	grind, 45 sec.	fast, 140°C	Timed	4 min	10.51
<b>Personal Care</b>							
ZZ5001	Liquid hand soap	1 g	spread thin on pad	step, 190°C 3 min, 130°C 1 min	A30	6 min	83.57
ZZ5002	Soap	2 g	shaved thin into dish	standard, 160°C	A30	4:30 min	20.83
ZZ5003	Toothpaste	1 g	spread thin on pad	fast, 125°C	A30	4 min	37.43
ZZ5004	Skin cream	1 g	spread thin on pad	step, 190°C 3 min, 145°C 8 min, 145°C	A30	12 min	87.11
ZZ5005	Stick deodorant	2 g	shaved thin into dish	standard, 190°C	A30	14 min	92.40
ZZ5006	Powdered detergent	3 g	as is	standard, 110°C	A30	3 min	3.27
<b>Misc.</b>							
ZZ6001	Latex paint	1 g	sandwich between pads	fast, 170°C,	A60	4:30 min	44.91
ZZ6002	Wood glue	1 g	spread thin on pad	standard, 160°C	A30	12 min	68.51





Ohaus Corporation  
7 Campus Drive  
Suite 310  
Parsippany, NJ 07054 USA  
Tel: (973) 377-9000,  
Fax: (973) 944 -7177

[www.ohaus.com](http://www.ohaus.com)

With offices worldwide.



P/N 30241176 E © 2017 Ohaus Corporation, all rights reserved.

Printed in China